



HD/SD 5-inch LCD Monitor

---

# **DM-3105**

Instruction Manual

Ver.1.00





---

HD/SD 5-inch LCD Monitor

---

**DM-3105**  
Instruction Manual

---

2008.4

Ver.1.00

ASTRODESIGN,Inc



# Contents

Introduction.....	iii
Safety Precautions .....	iii
About This Equipment.....	iii
About the Power Cord.....	iii
About Foreign Particles.....	iv
About the Power Supply.....	iv
About the Liquid Crystal.....	iv
About Shock of Impact.....	v
About the Installation and Operation Environment.....	v
Chapter 1. About the DM-3105 .....	1
DM-3105 Overview.....	1
Chapter 2. Names of Parts.....	3
2.1 DM-3105 Front Panel and Part Names.....	3
2.2 DM-3105 Rear Panel and Part Names.....	6
Chapter 3. How to Use.....	11
3.1 How to Connect .....	11
3.2 How to Use .....	11
3.3 About the Screen .....	12
3.3.1 Normal screens .....	12
3.3.2 Menu Screens .....	15
3.4 Operations Using Special Switches .....	16
3.4.1 Switching the Input Signal .....	16
3.4.2 Adjusting the Offset Level for the Brightness Signal.....	17
3.4.3 Adjusting the Contrast of the Brightness Signal .....	17
3.4.4 Adjusting the Pb(Cb) Value .....	18
3.4.5 Adjusting the Pr(Cr) Value .....	18
3.4.6 Simultaneously Adjusting Pb(Cb)·Pr(Cr) Values.....	19
3.4.7 Adjusting the Peaking Value.....	19
3.4.8 Adjusting Hue .....	20
3.4.9 Setting Audio Output .....	20
3.4.10 Adjusting Gain for the Displayed Waveform or Vector .....	21
3.4.11 Displaying the Menu Screen.....	21
3.5 Operations From Within the Menu .....	22
3.5.1 Making Detailed Settings for the Video Display Screen .....	23
3.5.2 Setting the Aspect Ratio .....	26
3.5.3 Making Marker Settings .....	27
3.5.4 Making Tally Settings .....	29
3.5.5 Making Audio Level Meter Settings.....	32

3.5.6 Making Simple Waveform Display Settings .....	35
3.5.7 Making Vector Display Settings .....	37
3.5.8 Making ID Settings .....	39
3.5.9 Making Screen Display and Layout Settings.....	42
3.5.10 Assigning Functions to Front Switches .....	46
3.5.11 Making Remote Controller Settings.....	48
3.5.12 Saving, Loading and Renaming Settings and Destroying Saved Settings .....	51
3.5.13 Restoring Defaults.....	53
3.5.14 Making Detailed LCD Settings .....	54
3.5.15 Making Basic Settings for the Main Unit.....	56
<b>Chapter 4. Main Specifications.....</b>	<b>59</b>
4.1 Input Formats.....	59
4.2 Input Signal Systems .....	60
4.3 Display System.....	61
4.4 Headphone Output.....	62
4.5 Adjustment Values.....	62
4.6 Aspect Ratio .....	64
4.7 The Audio Level Meter .....	65
4.7.1 Audio Level and Cell Coloration.....	65
4.7.2 Display Format and Cell Coloration.....	67
4.8 Contact Type Remote Controllers.....	69
4.8.1 Operation Example .....	69
4.8.2 Setting Values During Level Operations .....	71
4.9 Setting Values at Time of Initialization.....	72
4.9.1 Setting Items by Channel .....	72
4.9.2 Shared Setting Items.....	73
4.9.3 Automatically Saved Items .....	77
4.9.4 Resetting the Error Count and Elapsed Time.....	78
4.10 General Specifications.....	79
4.11 External View.....	80
4.11.1 DM-3105 External View (Main Unit).....	80
<b>Chapter 5. Accessories and Options.....</b>	<b>81</b>
5.1 Accessories .....	81
5.2 Options .....	81
<b>Chapter 6. Maintenance, etc. ....</b>	<b>83</b>
If the unit does not function normally .....	83
The following items do not indicate a problem with or damage to the unit .....	84
If an Error or Problem Occurs.....	84

## Introduction

Thank you for purchasing this DM-3105 HD LCD PICTURE MONITOR.

This manual gives the information necessary for using the DM-3105 including the method of operation and precautions.

Inappropriate handling may result in an accident. Be absolutely sure to read this manual so that you can correctly use the DM-3105.

After reading this manual, store it safely so that it will not be lost.

## Safety Precautions

### **WARNING**

#### About This Equipment

---

- **Do not strike or subject this equipment to strong impact. This may result in leakage of liquid crystal, damage to equipment, bursting, overheating, or fire.**
- **Do not use this equipment in a location where there is a risk of catching fire or explosion.**
- **Do not place in a food heating appliance such as a microwave oven or in a high-pressure container. This may result in overheating of equipment, generation of smoke, generation of fire, or destruction of circuit components.**
- **This equipment includes high-voltage parts inside. Do not disassemble, repair, or modify this equipment as there is a risk of electric shock or burn injury and doing so may result in damage to equipment.**
- **If thunder occurs during use outdoors, immediately turn off the power, disconnect the power cord from the main unit, and move to a safe location.**

#### About the Power Cord

---

- **When unplugging the power cord, always grasp the plug to unplug.**
- **Do not unduly bend or twist the power cord. This may result in fire.**
- **Do not place heavy objects on the power cord. This may damage the cord, resulting in fire or electric shock.**

## About Foreign Particles

---

- **Do not spill liquid inside or drop easily flammable or metallic objects inside. Continued use under these conditions may result in fire, electric shock, or damage to equipment.**



## About the Power Supply

---

- **Use 8 to 18V DC for the power supplied to this equipment.**
- **To prevent equipment damage and/or failure, we recommend the use of the supplied AC/DC adaptor. Pay attention to the rated voltage if for some reason you use another power supply.**
- **After power is turned off, do not immediately turn it on again. This may result in damage to equipment.**
- **Note that there is a risk of adverse effects on audio if the same DC power supply is used for the mic, amp, speakers, or other acoustic components.**

## About the Liquid Crystal

---

- **Due to the characteristics of liquid crystal, some pixels may be missing (or bright or flashing).**
- **Do not touch the liquid crystal if it leaks from the LCD panel.**

If the LCD panel accidentally breaks and liquid crystal leaks out, do not put it in your mouth, breathe it, or allow it to contact your skin. If you do somehow get liquid crystal in your mouth or eyes, wash the affected area immediately with water. In addition, if liquid crystal gets on your skin or clothing, immediately wipe it away with alcohol or other agent and wash away with soap and water. There may be damage to skin or clothing if contact is allowed to continue.
- **Beware of broken glass of the LCD panel.**

If the LCD panel breaks, take great care not to cut your hands on the glass shards. Injury may result if you do somehow touch the broken surface.



■ **Handle the LCD panel with care as described below as it is an extremely high-precision instrument.**

- Wiping the LCD panel with benzene, thinner, or other active agent may result in deformation.
- If water (or salt water) is allowed to stay in contact with the LCD panel, this may result in change in color or blemishes.
- If the LCD panel is subjected to direct ultraviolet light for an extended period, there is a risk of degradation of display quality due to lowered contrast caused by bronzing of the deflection plate.
- Irregular colors may result if moisture gets inside the LCD panel due to condensation or by other means.
- Directly striking or bumping into the LCD panel may result in cracking or other damage to the LCD panel.
- Do not disassemble the LCD panel as it is dangerous if leaked liquid crystal comes in contact with skin.

■ **Take care when handling the liquid crystal protective panel.**

Gently wipe away any grease or dirt that contacts the liquid crystal protective panel using a cleaner for office equipment. Wiping forcefully may result in scratching or damage to equipment.

## About Shock of Impact

---

- **As a precision instrument, there is a risk of damage to equipment if the equipment is subjected to shock of impact. Take sufficient care when moving the equipment.**
- **Do not drop the main unit.**

## About the Installation and Operation Environment

---

■ **Installation in the following locations may result in accident or damage to equipment.**

- Locations where the ambient temperature is outside the range 0 to 40 °C (\*1)
- Locations where the ambient humidity is outside the range 30 to 80%RH.
- Locations near an air conditioning unit, or where there is condensation or sudden changes in temperature.
- Locations subject to direct sunlight. (\*2)
- Locations where there is corrosive gas or excessive dust.
- Locations where there are strong magnetic fields.
- Locations where there is a risk of equipment being sprayed with airborne droplets such as water, oil, or chemicals.
- Locations where vibrations reach equipment through the floor.
- Unstable locations.

■ **To ensure normal operation of this equipment, take care that the following conditions are met.**

- Do not place heavy objects such as a monitor on top of this equipment.
- Avoid placing objects in the immediate surrounding of this equipment.

(\*1) If the surface temperature of the LCD panel exceeds 60 °C, there is a risk that the backlight or other parts may be damaged.

(\*2) If the LCD panel is subjected to direct ultraviolet light for an extended period, there is a risk of degradation of display quality due to lowered contrast caused by bronzing of the deflection plate.

# 1

## About the DM-3105

The DM-3105 is a compact, light-weight LCD monitor for the HD broadcast industry suitable for mobile video monitoring when on location or reporting from the field.

This equipment supports 21 types of HDTV input signals and 2 types of SDTV video formats.

In addition to picture quality adjustments and display functions such as brightness adjustment, contrast adjustment, chroma adjustment, and marker display, this monitor is equipped with various functions including video level monitoring functions such as simple waveform display and simple vector display.

### DM-3105 Overview

- **Utilizes a 5.0-inch TFT LCD panel**

(Viewing angle: Left-right: 170° Up down: 170°; WVG A: 800x480)

- **Supports HD-SDI, SD-SDI signals and composite signal input**

- **Supports 21 types of video formats**

Supported HD-SDI specifications: Conforms for SMPTE292M and BTA S-004B standard specifications (1.485 Gbit/s SDI input)

Supported SD-SDI specification: Conforms to SMPTE259M standard specifications (270 Mbit/s SDI input)

Supported composite signal specifications: NTSC: SMPTE 170M

PAL: ITU-R624-4 (excluding PAL-N and PAL-M)

- **Automatic format tracking, automatic frame rate tracking for 1/1.000 and 1/1.001, and automatic input signal detection function**

- Equipped with SDI IN, SDI MONITOR OUT, and COMPOSITE terminals
- Brightness, contrast, chroma, view, monochrome, and gamma adjustment functions
- Marker display function  
(FRAME, CENTER, 95%, 93%, 88%, 80%, 4:3, 13:9, 14:9, 2.35:1, 1.85:1, 1.66:1, Grating, BOX, USER)
- Allows user-defined aspect ratio settings  
(HD:V\_FULL, 16:9, Actual Size, Blanking, Under Scan, SCOPE SD:4:3, 16:9, Twice Size, Blanking, Under Scan)
- Allows user-defined front switch settings  
(Including aspect select, monochrome, blue only, display/hide marker, and chroma up functions, etc.)
- Allows user-defined remote controller settings  
(Including tally, input signal select, marker ON/OFF select, mask ON/OFF select, etc.)
- Allows color temperature selection of 5500K, 6500K, 9300K (fine color and gradation adjustments are also possible)
- CRC/EDH error detection function for the input channel
- Time code (VITC/LTC) display (DID: 260h, SDID: 260h only)
- Audio level meter display
- Audio level meter customization function
- Simple waveform, simple vector display functions (waveform and vector cannot be displayed simultaneously)
- Panel lock, setting value save function
- Allows user data to be saved and called up
- Thin, lightweight, and compact (can be placed in a rack as three linked monitors)
- DC power input (8 to 18V)

# 2

## Names of Parts

### 2.1 DM-3105 Front Panel and Part Names

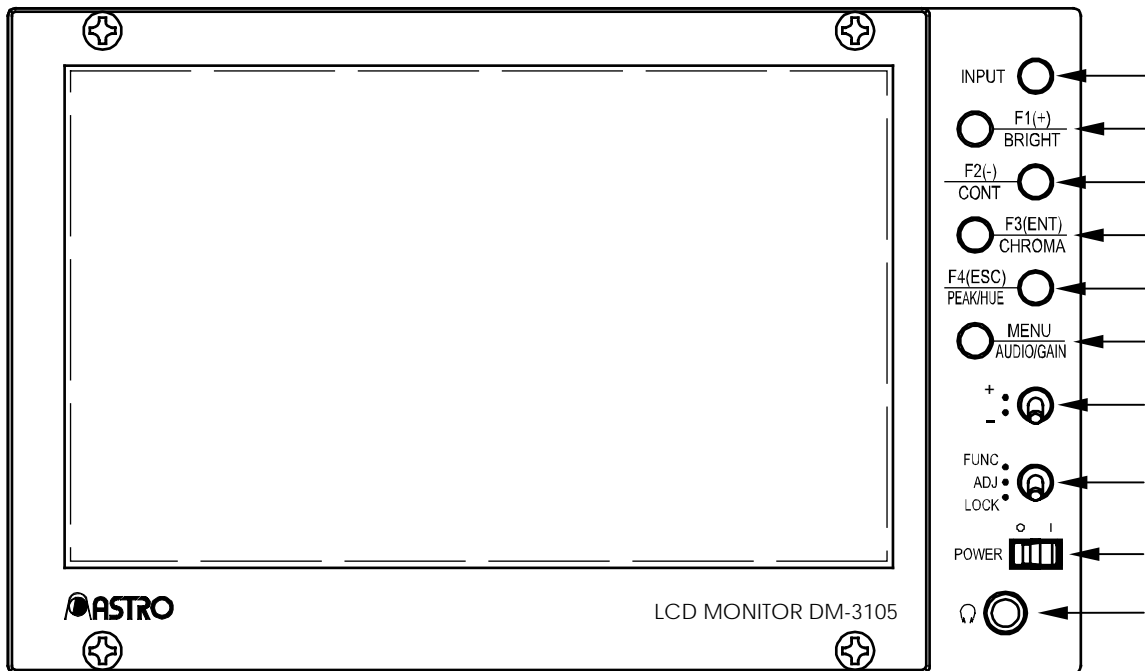

Figure 2.1 DM-3105 Front Panel

**Table 2.1 Front Panel Part Names**

No.	Name	Function	
	<i>POWER Switch/LED</i>	Turns power ON/OFF. (Lights green when power is input)	
	<i>Function select switch</i>	Switches the function of front switches or locks operations.	
	<i>Liquid Crystal Display</i>	Displays video images	
	<i>INPUT switch</i>	The video image displayed on the screen is switched in the following order: “HD/SD_SDI IN CH_A HD/SD_SDI IN CH_B COMPOSITE HD/SD_SDI IN CH_A”.	
	<i>F1(+)/BRIGHT switch</i>	When FUNC is selected	The function assigned to the switch is executed except during menu operations. (See Section 3.5.10) During, this switch moves the cursor left or up, or increases the value being adjusted.
		When ADJ is selected	Enters brightness adjustment. (See section 3.4.2)
	<i>F2(-) / CONTRAST switch</i>	When FUNC is selected	The function assigned to the switch is executed except during menu operations. (See Section 3.5.10) During menu operations, this switch moves the cursor right or down, or decreases the value being adjusted.
		When ADJ is selected	Enters contrast adjustment. (See Section 3.4.3)
	<i>F3(ENT) / CHROMA switch</i>	When FUNC is selected	The function assigned to the switch is executed except during menu operations. (See Section 3.5.10) During menu operations, this switch used the value being adjusted and changes the level
		When ADJ is selected	When using YPbPr (Color Space) Enters chroma adjustment. Each time this switch is pressed, the setting changes in the following order: “Chroma Pb Pr Exit adjustment”. (See Sections 3.4.4 to 3.4.6)
		When using GBR (Color Space)	Chroma adjustment cannot be performed.

	<i>F4(ESC) / PEAK / HUE switch</i>	When FUNC is selected	The function assigned to the switch is executed except during menu operations. (See Section 3.5.10) During menu operations, this switch cancels the value being changed and exits the adjustment.	
		When ADJ is selected	When using YPbPr (Color Space)	Enters peak value adjustment or hue adjustment. The peak value can be adjusted when peaking is ON. Each time this switch is pressed., the setting changes in the following order: "Peak Hue Exit adjustment". (See Section 3.4.7 to 3.4.8)
			When using GBR (Color Space)	Enters peak adjustment. Peak values can be adjusted when peaking is ON. Hue adjustment cannot be performed. (See Section 3.4.7)
	<i>MENU / AUDIO / GAIN switch</i>	When FUNC is selected	Turns the menu screen ON/OFF. When the menu screen is ON, switches through function as -, +, ENT, and ESC, respectively. When the menu screen is OFF, switches through function as F1, F2, F3, and F4, respectively.	
		When ADJ is selected	Enters output audio volume adjustment, output channel setting, or gain adjustment for displayed waveform/vector. Each time this switch is pressed, the setting changes in the following order: "Volume L_CH R_CH Wave_Gain or Vector_Gain Exit adjustment" when a waveform or vector is displayed, and in the following order: Volume L_CH R_CH Exit adjustment" when a waveform or vector is not displayed. (See Sections 3.4.9 through 3.4.10)	
	<i>+ / - switch</i>	Used to adjust setting values.		
	<i>Headphone jack</i>	Outputs the audio included in the input signal in stereo.		

## 2.2 DM-3105 Rear Panel and Part Names

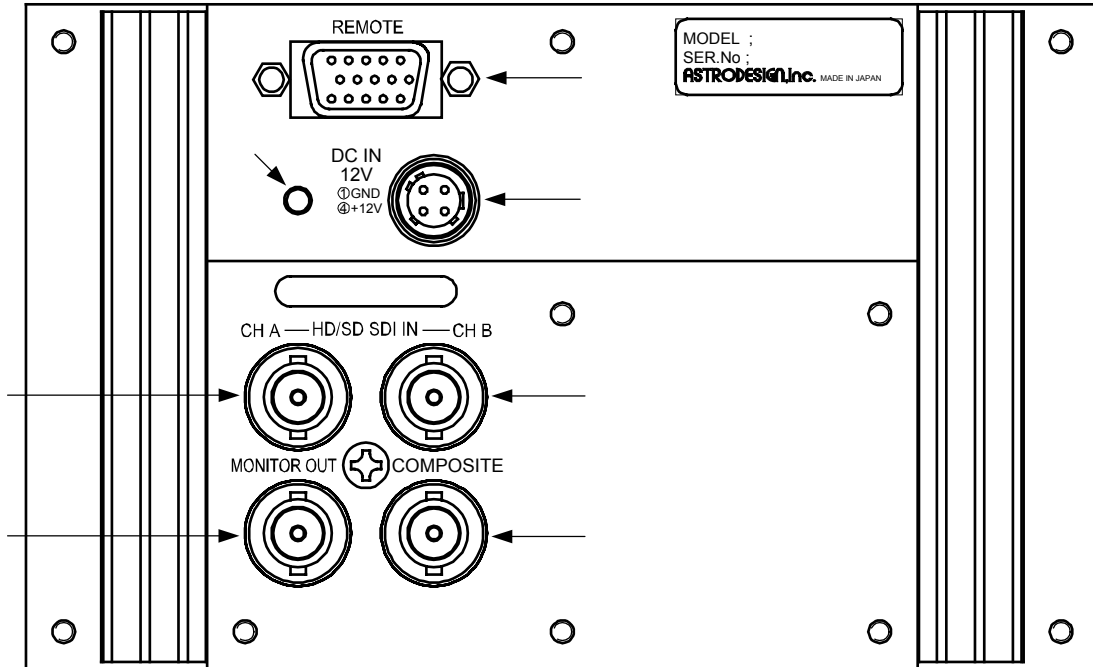

Figure 2.2 DM-3105 Rear Panel



Table 2.2 Rear Panel Part Names

No.	Name	Function
	Power Connector (*1)	Camera connector DC power input terminal (GND 1 pin, DC IN 4 pins)
	<i>HD/SD SDI IN A</i>	HD-SDI, SD-SDI signal input terminals
	<i>HD/SD SDI IN B</i>	HD-SDI, SD-SDI signal input terminals
	<i>MONITOR OUT</i>	Output terminals for performing a simple check of the SDI input signal
	<i>COMPOSITE</i>	Composite signal input terminals
	Remote Connector (*2)	D-sub 15-pin (male)
	<i>Rear panel tally LED</i>	Supports TALLY1-Red and TALLY2-Green (no TALLY3 or TALLY4)

\*1 Power connector (No. (1))

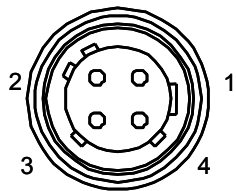

Pin No.	Function
1	GND
2	GND *
3	DC IN(8-18V) *
4	DC IN (8-18V)

Note: Pins 2 and 3 are used when driving with a compact battery (low voltage).  
Operates using NC when using the usual power supply (12V type).

\*2 Remote connector (No. (6))

The remote controller is enabled only when ENABLE\_RMT is MAKE (Low level).

For details on the remote controller, see Section 4.8.

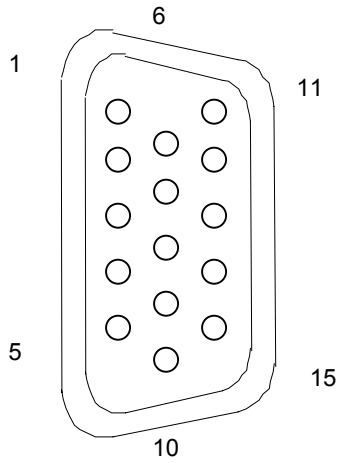

Pin No.	Signal	Initial value
1	GND	
2	Remote Control 1	Non
3	Remote Control 2	Non
4	Remote Control 3	Non
5	ENABLE_RMT	
6	Remote Control 4	Non
7	Remote Control 5	Non
8	Remote Control 6	Non
9	Remote Control 7	Non
10	Remote Control 8	Non
11	Remote Control 9	Non
12	Remote Control 10	Non
13	Remote Control 11	Non
14	Remote Control 12	Non
15	GND	

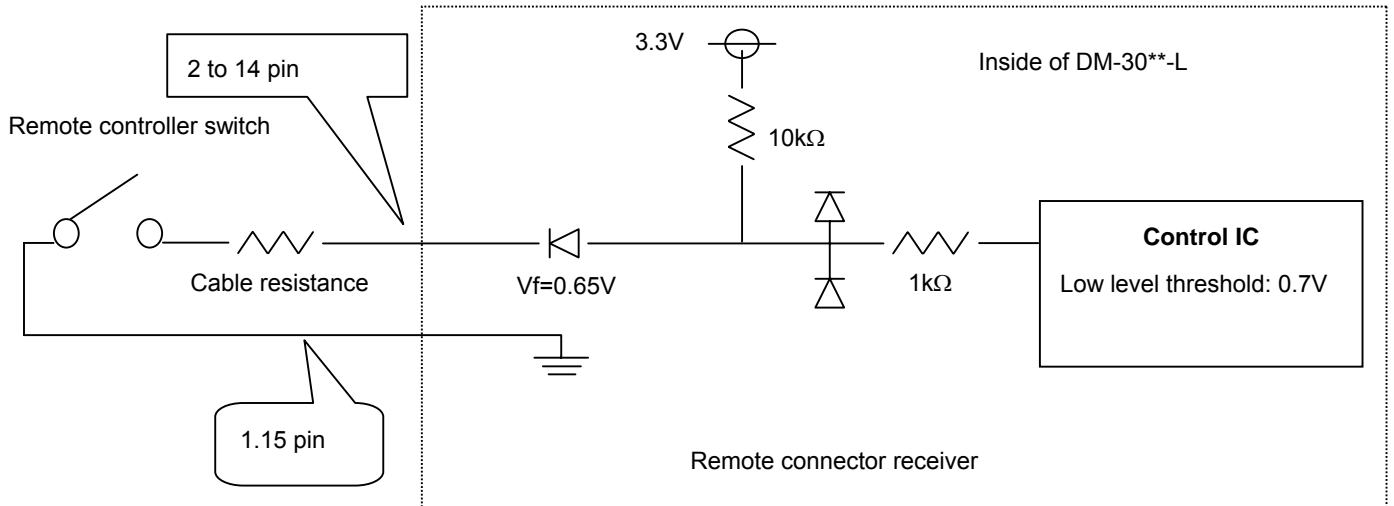

Note: Design for a cable resistance fo  $50\Omega$  or less.



Do not connect or disconnect the Remote Connector while power is on.



# 3

## How to Use

### 3.1 How to Connect

This section describes how to connect the DM-3105.

#### (1) Connecting the power supply

Check that the POWER switch of this unit is OFF, and then connect the camera connector end of the Canon Camera Connector Adaptor Cable to the POWER Connector of the DM-3105 (Part No. (1) in the Rear Panel Diagram.) The camera connector end of the adaptor cable connects to the Canon connector of the AC/DC adaptor.

If you are using a power supply other than that supplied, please check the connector shape and pin arrangement.

#### (2) Input signal connections

To input an SDI signal, connect to SDI IN with a BNC coaxial cable.

SDI IN is used for SDI signal input, while the output from MONITOR OUT is used for simple monitoring of the SDI input signal.

Input a serial signal conforming to BTA S-004B for the HD-SDI input signal.

Furthermore, use a coaxial cable (5C-FB or equivalent) capable of handling the 1.5GHz band.

Input a serial signal conforming to SMPTE259M (270 Mbits/s) for the SD-SDI input signal.

Furthermore, to input a composite signal, connect a BNC coaxial cable to COMPOSITE as described above.

When using a composite signal, input a signal that conforms to SMPTE170M in the case of NTSC, or a signal conforming to ITU-R624-4 in the case of PAL.

#### (3) Remote controller connections

Check that the POWER switch of this unit is OFF, and connect the remote controller to the Remote Connector (Part No. (6) in the Rear Panel Diagram).

Be sure to check the shape of the connector before use.

### 3.2 How to Use

A protective film is attached to the surface of the liquid crystal protective panel. Remove this protective film before using the DM-3105.

After checking connections, press the POWER switch and turn on the power of the DM-3105. The POWER LED lights, and video is displayed.

If the POWER LED does not light, check connections one more time.

To monitor the SDI input signal, use MONITOR OUT.

If there is no input signal, the video area turns black and  NoSignal is displayed in red on the screen.

Note: If display of a color bar pattern is set when there is no input, a color bar will be displayed in the video area.

## 3.3 About the Screen





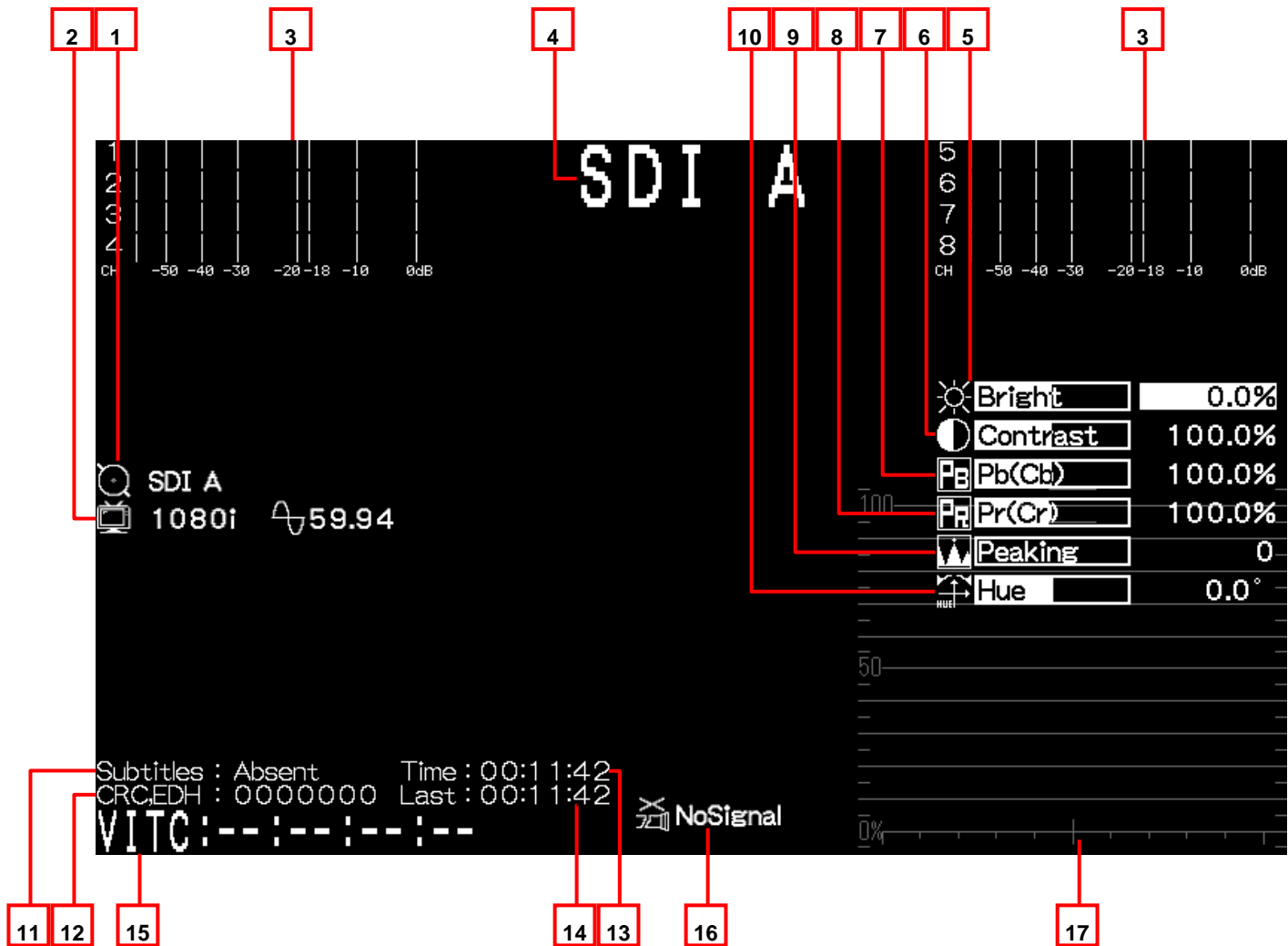













This section describes on the -screen displays of the DM-3105.

### 3.3.1 Normal screens



#### Supplement

1, 2, 3, 4, 11, 12, 13, 14, 15, and 17 can be hidden from display. The display position and other attributes can also be changed. (See section 3.5.9)

No.	Item	Description	
1	 (Input CH)	Displays the selected input channel.	
2	 (Format)  (Frequency)	Displays the format and field (frame) frequency detected from the input signal. If there is no input signal (during NoSignal),  is displayed. (For details on the format, see Section 4.1.)	
3	 ch*	Displays the audio level meter. (See Section 4.7)(*1)	
4	(CH ID)	Displays the name assigned to the selected input channel.	
5	 Bright	Displays the brightness setting value. (See Section 4.5)	
6	 Contrast	Displays the contrast setting value. (See Section 4.5)	
7	 Pb(Cb)	When the Color Space is YPbPr	Displays the Pb(Cb) setting value. (See Section 4.5)
		When the Color Space is GBR or XYZ	N/A is displayed and default settings are temporarily set. (Pb(Cb) cannot be set.)
8	 Pr(Cr)	When the Color Space is YPbPr	Displays the Pr(Cr) setting value (See Section 4.5)
		When the Color Space is GBR or XYZ	N/A is displayed and default settings are temporarily set. (Pb(Cr) cannot be set.)
9	 Peaking	Displays the peaking setting value.	
10	 Hue	When the Color Space is YPbPr	Displays the Hue setting value.
		When the Color Space is GBR or XYZ	N/A is displayed and default settings are temporarily set. (Hue cannot be set.)
11	 Subtitles	Displays whether subtitle data is enabled. (*2)	
12	 CRC, EDH	Checks for CRC errors during HD-SDI signal input, and for EDH errors during SD-SDI signal input, and displays the number of errors.(*2) If an error occurs,  will be displayed in red for one second.	
13	 Time	Displays the elapsed time since the DM-3105 was turned on.	
14	 Last	Displays the elapsed time since the last CRC or EDH error occurred. (*2)	
15	 VITC	Displays the time code (VITC). (*2) (*3)	
16	 NoSignal	 is displayed in red if there is no input signal.	
17	(Waveform/Vector)	Displays a simple waveform or vector. (*2)	

(\*1) The audio level meter is not activate because audio is not output when a composite signal is selected.

(\*2) Not displayed when a composite signal is selected.

(\*3) The only time code standards supported by this unit are DID: 260h and SDID: 260h.

No other standards (such as RP196 or SMPTE291M) are supported.

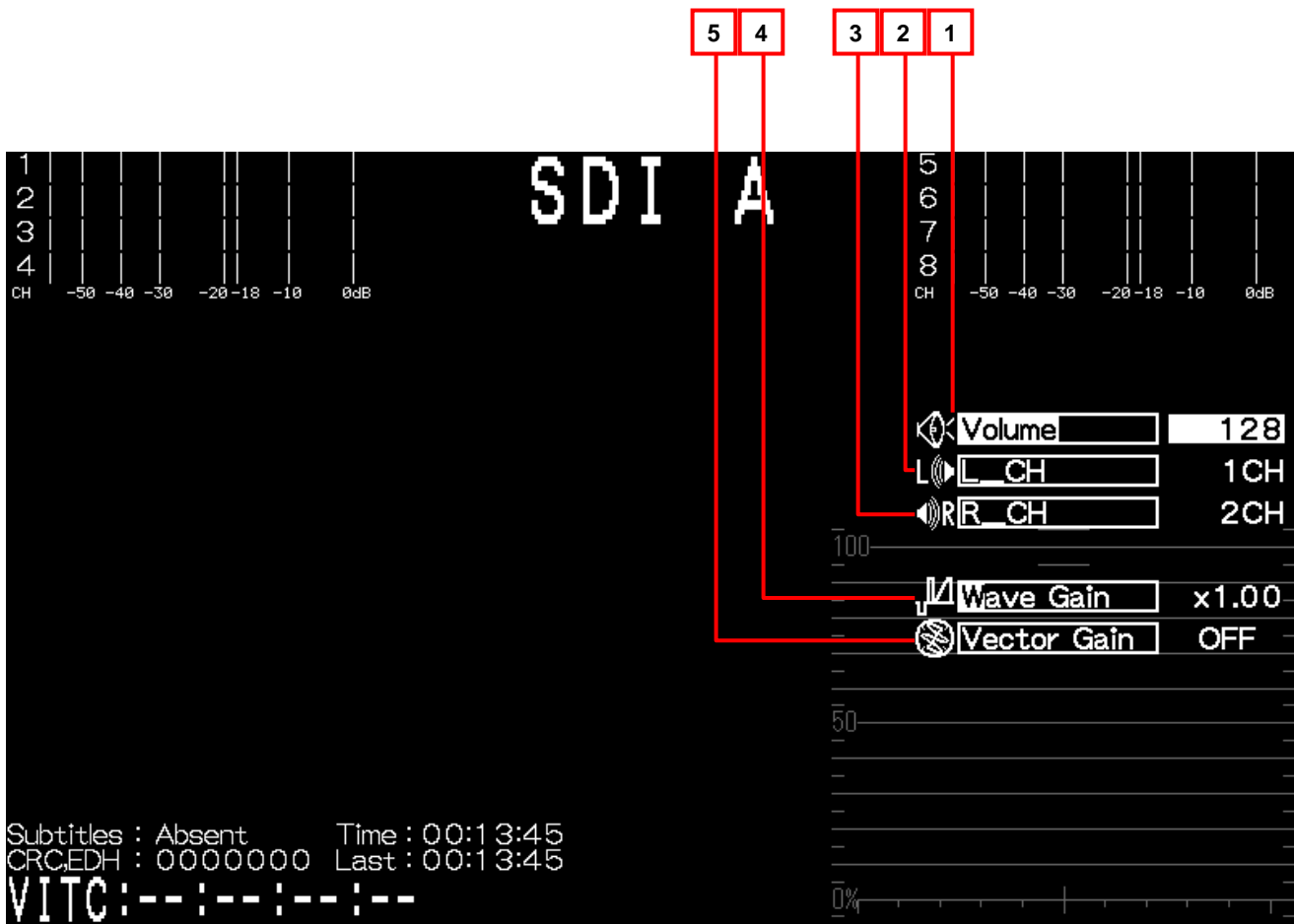

No.	Item	Description
1	Volume	Displays the audio volume setting for output from the headphone jack.
2	L_CH	Displays the audio channel being output to the left.
3	R_CH	Displays the audio channel being output to the right.
4	Wave_Gain	Displays the scaling ratio setting in the vertical direction for the displayed waveform.
5	Vector_Gain	Displays the scaling ratio setting for the vector being displayed.



### 3.3.2 Menu Screens

Pressing the MENU Switch displays the following screen, on which various function can be executed.

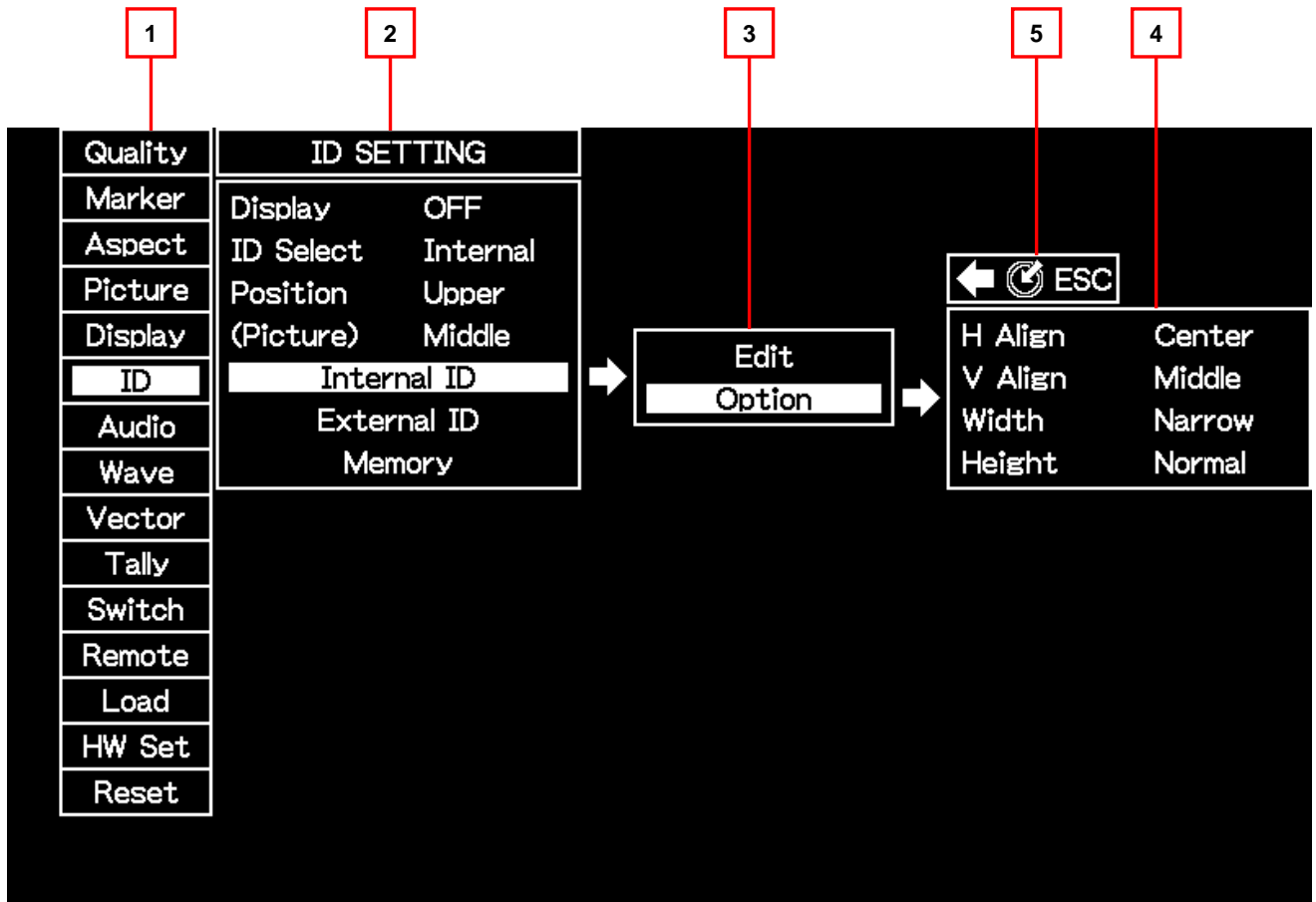

No.	Description
1	Menu Level 1 1
2	Menu Level 2
3	Menu Level 3
4	Menu Level 4
5	Pressing the adjustment dial in this condition goes up one menu level.

\* The number of levels displayed differs depending on the menu.

## 3.4 Operations Using Special Switches

Except for Front Switches F1 through F4, all switches become special switches. This section describes operations controlled using each special switch.



Items accompanied with this mark can also be controlled using the remote controller. For details on these operations, see Item 3.5.11.

### 3.4.1 Switching the Input Signal



#### ■ Using Front Switches

1. Press the INPUT switch.

#### ■ Using the Remote Controller

1. Press the switch assigned to the SDI A/B or SDI/Analog function.

#### Supplement

Each time the INPUT switch is pressed, the signal is displayed in the following order: "HD/SD\_SDI IN CH\_A → HD/SD\_SDI IN CH\_B → COMPOSITE → HD/SD\_SDI IN CH\_A".

The INPUT Switch is enabled whether the Function Select Switch is set to FUNC or ADJ.

The SDI A Switch displays the signal input to HD/SD SDI IN CH A, the SDI B Switch displays the signal input to HD/SD SDI IN CH B, and the ANALOG Switch displays the signal input to COMPOSITE.

### 3.4.2 Adjusting the Offset Level for the Brightness Signal

---

1. Set the Function Select Switch to ADJ, press the BRIGHT Switch, and adjust the brightness value (brightness signal offset level) by pressing the +/- Switches.

**Supplement**

The adjustable range is -50.00 to +50.00% (See Section 4.5)  
To exit from brightness adjustment, press the BRIGHT Switch one more time.

### 3.4.3 Adjusting the Contrast of the Brightness Signal

---

1. Set the Function Select Switch to ADJ, press the CONTRAST Switch, and adjust the contrast value (brightness signal contrast) by pressing the +/- Switches.

**Supplement**

The adjustable range is 0.0 to 200.0% (See Section 4.5)  
To exist from contrast adjustment, press the CONTRAST Switch one more time.

### 3.4.4 Adjusting the Pb(Cb) Value

---

1. Set the Function Select Switch to ADJ, press the CHROMA Switch, and select Pb(Cb) only.
2. Adjust the Pb(Cb) value (color difference signal level) by pressing the +/- Switches.

#### Supplement

The adjustable range is 0.0 to 200.0% (See Section 4.5)  
Each time the CHROMA Switch is pressed, the setting changes in the following order: "CHROMA → Pb(Cb) → Pr(Cr) → Exit from adjustment."

#### Caution

This is only enabled when YPbPr is selected for the .

### 3.4.5 Adjusting the Pr(Cr) Value

---

1. Set the Function Select Switch to ADJ, press the CHROMA Switch, and select Pr(Cr) only.
2. Adjust the Pr(Cr) value (color difference signal level) by pressing the +/- Switches.

#### Supplement

The adjustable range is 0.0 to 200.0% (See Section 4.5)  
Each time the CHROMA Switch is pressed, the setting changes in the following order: "CHROMA    Pb(Cb)    Pr(Cr)    Exit from adjustment."

#### Caution

This is only enabled when YPbPr is selected for the .

### 3.4.6 Simultaneously Adjusting Pb(Cb)·Pr(Cr) Values

1. Set the Function Select Switch to ADJ, press the CHROMA Switch, and select Pb(Cb) and Pr(Cr).
2. Adjust the chroma values (color difference signal levels) by pressing the +/- Switches.

#### Supplement

The adjustable range is 0.0 to 200.0% (See Section 4.5)  
 Further adjustment is not possible once the maximum value or minimum value is selected for either Pb(Cb) or Pr(Cr).  
 Each time the CHROMA Switch is pressed, the setting changes in the following order: "CHROMA Pb(Cb) Pr(Cr) Exit from adjustment."

#### Caution

This is only enabled when YPbPr is selected for the .

### 3.4.7 Adjusting the Peaking Value

1. Set the Function Select Switch to ADJ, press the PEAK/HUE Switch, and select Peaking.
2. Adjust the peaking values by pressing the +/- Switches.

#### Supplement

Adjustment is possible only when peaking is ON. (The adjustable range is 0 to 100.)  
 Each time the PEAK/HUE Switch is pressed, the setting changes in the following order: "Peaking → Hue → Exit from adjustment."  
 Peaking is turned ON/OFF using the MENU.

#### Caution

G signal peaking results if GBR is selected for the .

Horizontal banding may stand out if peaking is overly applied when using a 16:9 aspect ratio with 1080i input.

### 3.4.8 Adjusting Hue

---

1. Set the Function Select Switch to ADJ, press the PEAK/HUE Switch, and select Hue.
2. Adjust the Hue value by pressing the +/- Switches.

#### Supplement

The adjustable range is -179.0 to 180.0°.  
Each time the PEAK/HUE Switch is pressed, the setting changes in the following order: "Peaking → Hue → Exit from adjustment."

#### Caution

This is only enabled when YPbPr is selected for the . If the  is GBR or XYZ, Hue cannot be selected even by pressing the PEAK/HUE Switch.

### 3.4.9 Setting Audio Output

---

1. Set the Function Select Switch to ADJ, press the AUDIO/GAIN Switch, and select Volume or L\_CH, or R\_CH.
2. Adjust the volume level or output channel by pressing the +/- Switches.

#### Supplement

The adjustable range for volume is 0 to 255.  
Holding down the AUDIO/GAIN Switch will mute the output audio. MUTE status is canceled by holding down the AUDIO/GAIN Switch or re-adjusting the volume.  
The selectable audio channels are Channels 1 through 16.  
The same channel can be selected for both L and R (monaural output).  
Each time the AUDIO/GAIN Switch is pressed, the setting changes in the following order: "Volume → L\_CH → R\_CH → Wave\_Gain or Vector\_Gain → Exit from adjustment." If no waveform or vector is to be displayed, exit from adjustment without selecting Wave\_Gain or Vector\_Gain.

### 3.4.10 Adjusting Gain for the Displayed Waveform or Vector

---

1. Set the Function Select Switch to ADJ, press the AUDIO/GAIN Switch, and select Wave\_Gain or Vector\_Gain.
2. Adjust the waveform or vector gain by pressing the +/- Switches.

**Supplement**

The adjustable range for Wave\_Gain is x0.01 to 7.99.

The adjustable range for Vector\_Gain is x0.01 to 7.99.

Wave\_Gain can be adjusted when a waveform is being displayed, and

Vector\_Gain can be adjusted when a vector is being displayed.

Each time the AUDIO/GAIN Switch is pressed, the setting changes in the following order: "Volume → L\_CH → R\_CH → Wave\_Gain or Vector\_Gain → Exit from adjustment." If no waveform or vector is to be displayed, exit from adjustment without selecting Wave\_Gain or Vector\_Gain.

### 3.4.11 Displaying the Menu Screen

---

1. Set the Function Select Switch to FUNC, press the MENU Switch, and select whether to display or hide the Menu screen.

**Supplement**

For details on items that can be controlled from within the menu, see the next section.

## 3.5 Operations From Within the Menu

Further details settings can be made using the menu.

This section describes operations that can be controlled and set within each menu item.



Items accompanied with this mark can also be controlled using the remote controller.

For details on these operations, see Item 3.5.11.



Items accompanied with this mark are operations that can be controlled using the F1 through F4 switches.

For details on these operations, see Item 3.5.10.



### 3.5.1 Making Detailed Settings for the Video Display Screen

This section describes items listed under Picture in the menu.

#### ■ Basic Operation





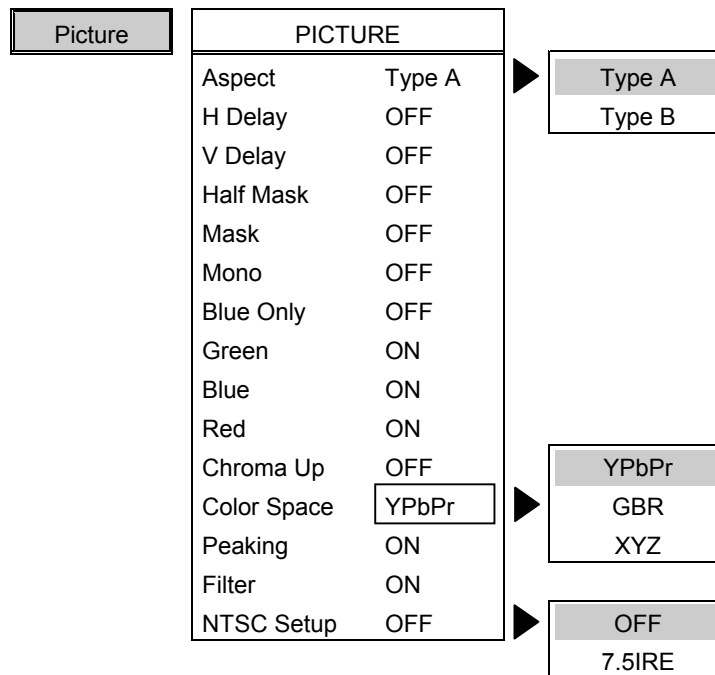

1. Set the Function Select Switch to FUNC, press the MENU Switch, and display the Menu screen.
2. Choose **Picture** by pressing the +/- Switches and then press the ENT Switch.
3. Choose the item to be adjusted by pressing the +/- Switches, and then select by pressing the ENT Switch.



#### ■ MENU Hierarchical Screen Image



Note: The currently selected item is displayed in reverse text.

■ Detailed Descriptions of Each Item

Item	Description	Remarks
Aspect	Switches the aspect ratio between Type A and Type B.	
H Delay	Switches the horizontal delay ON/OFF.	<p>Cancels mask and half-mask when using H delay.</p> 
V Delay	Switches vertical delay ON/OFF.	
Half Mask	Switches half-mask ON/OFF.	<p>Applies a mask or half-mask to the region outside that set using markers or outside the 4:3 region when using a 16: 9 aspect ratio.</p>
Mask	Switches between mask ON/OFF.	<p>If both mask and half-mask are ON, mask is given priority. (* Supplement 1)</p> <p>Cancels mask and half-mask when using H delay.</p> 
Mono	Switches between a monochrome and color display.	<p>Monochrome is turned OFF if ON/OFF is selected for any of blue only, G, B, or R when monochrome is ON.</p> <p>G, B, and R are all turned ON if monochrome ON/OFF is selected.</p> 
Blue Only	Switches between a blue only display and color display.	<p>Blue only is turned OFF if ON/OFF is selected for any of monochrom, G, B, or R when blue only is ON.</p> <p>G, B, and R are all turned ON when blue only is turned OFF.</p> 
Green	Switches between ON/OFF for the green component of video.	<p>If this switch is turned ON/OFF during monochrome or blue only, monochrome or blue only is turned OFF.</p> 
Blue	Switches between ON/OFF for the blue component of video.	
Red	Switches between ON/OFF for the red component of video.	

<b>Chroma Up</b>	Switches between ON/OFF for the multiplication of the chroma signal value.	When ON, the chroma signal value is multiplied by three. However, if the result of multiplying the chroma signal by three exceeds $\pm 109\%$ , a limit of $\pm 109\%$ is applied. (* Supplement 2) 
<b>Color Space</b>	Switches among YPbPr, GBR, and XYZ.	Several items cannot be adjusted when GBR or XYZ are selected.
<b>Peaking</b>	Switches between ON/OFF for peaking.	Even if peaking is turned ON, the peaking function is not enabled if the peaking adjustment level is 0. If GBR is selected for the <b>Color Space</b> , G signal peaking is performed. If XYZ is selected, Y signal peaking is performed. 
<b>Filter</b>	Switches between ON/OFF for the filter.	If peaking is enabled, the filter is disabled if either H delay or V delay are being used. (* Supplement 3)
<b>NTSC Setup</b>	Switches between ON/OFF for NTSC setup.	Select OFF when inputting an NTSC signal with setup 0, or 7.5IRE when inputting a signal that includes setup.

**Supplement 1** The mask and half-mask functions are visibly active for the following aspect ratios.

ASPECT RATIO FORMAT	HD Input	SD Input
4:3 (V Full)	○	×
16:9	○	○
Actual Size <sup>(HD)</sup> Twice Size <sup>(SD)</sup>	×	×
Blanking	○	×
Under Scan	○	×
Scope <sup>(HD)</sup>	○	-

**Supplement 2**

Ex: Although a 30% signal can be expanded up to 90%, multiplying a 100% signal by x3 only results in an increase up to 109%.

**Supplement 3**

The format and aspect ratio combinations for which filters are active are as follows.

ASPECT RATIO FORMAT	4:3 <sup>(SD)</sup> V Full <sup>(HD)</sup>	16:9	Actual Size <sup>(HD)</sup> Twice Size <sup>(SD)</sup>	Blanking	Under Scan	Scope <sup>(HD)</sup>
1080i/sF/P			×			
720p			×			
525/59.94i			×	×	×	-
625/50i			×	×	×	-

### 3.5.2 Setting the Aspect Ratio

This section describes the Aspect item on the menu.

#### ■ Basic Operation

1. Set the Function Select Switch to FUNC and press the MENU Switch.
2. Choose Aspect by pressing the +/- switches and then press the ENT Switch.
3. Choose the Aspect to be changed by pressing the +/- switches and then press the ENT Switch.
4. Choose the Aspect to use after the change by pressing the +/- Switches and then press the ENT Switch.

Supplement

This setting selects the method of display used when either type A or type B HD signal input or SD signal input is used.  
For details on the aspect ratios that can be selected, see Section 4.6.

#### ■ MENU Hierarchical Screen Image

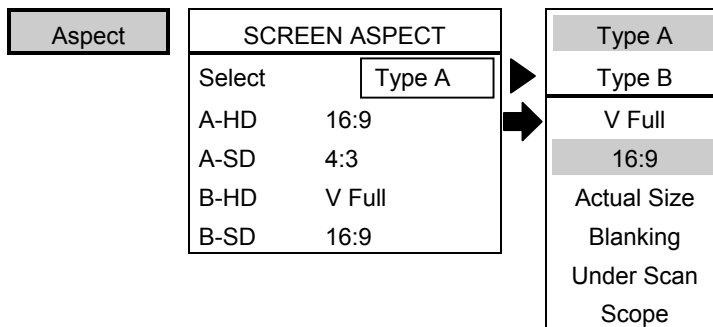

Note: The currently selected item is displayed in reverse text.

### 3.5.3 Making Marker Settings

This section describes the Marker item on the Menu.

#### ■ Basic Operation

1. Set the Function Select Switch to FUNC, press the MENU Switch, and display the Menu screen.
2. Choose **Marker** by pressing the +/- switches and then press the ENT Switch.
3. Choose the item to be changed by pressing the +/- switches and then press the ENT Switch to switch, or select and enter adjustment, and then press the ENT Switch to confirm.



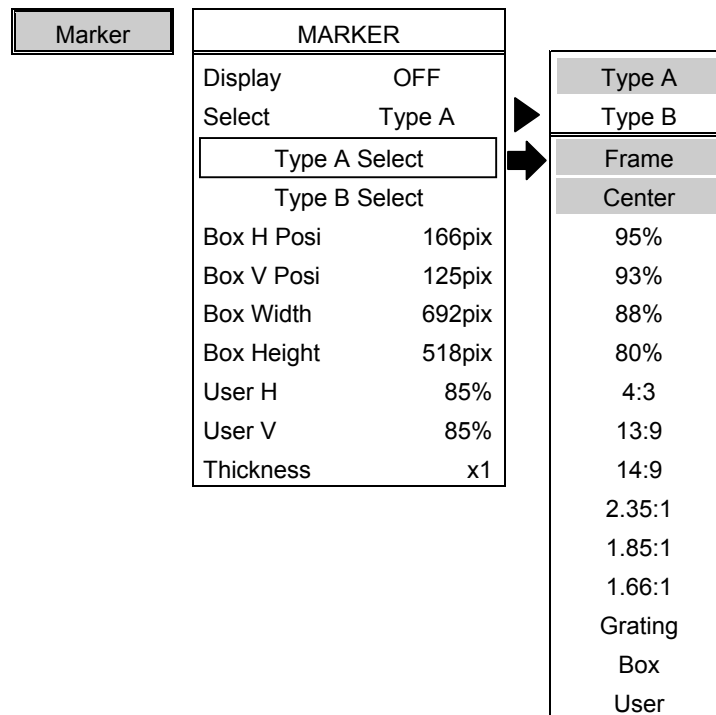

Note: The value being adjusted is not saved until the ENT Switch is pressed to confirm the entry. The value being adjusted is destroyed if you exit a menu before confirming it.

#### ■ MENU Hierarchical Screen Image



Note: The currently selected item is displayed in reverse text.

■ Detailed Descriptions of Each Item

Item	Description	Remarks
Display	Switches between displaying/hiding markers.	 
Select	Switches between Type A/Type B for the markers being displayed.	 
Type A Select	Selects the markers to be displayed by Type A.	Duplicate markers can be selected. The marker name of selected markers is shown in reverse text. (* Supplement) If there is no input signal, an HD type marker is displayed.
Type B Select	Selects the markers to be displayed by Type B.	
Box H Posi	Adjusts the horizontal display position of the box marker.	
Box V Posi	Adjusts the vertical display position of the box marker.	
Box Width	Adjusts the horizontal size of the box marker.	
Box Height	Adjusts the vertical size of the box marker.	
User H	Adjusts the horizontal display position of the user marker.	If the Aspect is 16:9, 4:3, Blanking, Under Scan, or Scope, this is given as a percent of the video area, if Aspect is Actual Size or Twice Size, this is given as a percent of the LCD panel.
User V	Adjusts the horizontal display position of the user marker.	
Thickness	Sets the thickness of the marker.	The line width used for frame markers and grid markers does not change.

**Supplement** The relationship between the selected format and aspect ratio and markers to be displayed is as follows

ASPECT RATIO MAKER NAME	HD						SD				
Frame	x	○	x	○	○		x	○	x	○	○
Center	○	○	○	○	○		○	○	○	○	○
95%	○	○	x	○	○	○	○	○	x	○	○
93%	○	○	x	○	○	○	○	○	x	○	○
88%	○	○	x	○	○	○	○	○	x	○	○
80%	○	○	x	○	○	○	○	○	x	○	○
4:3	x	○	x	○	○		x	○	x	x	x
13:9	x	○	x	○	○		○	○	x	x	x
14:9	x	○	x	○	○		○	○	x	x	x
2.35:1	x	○	x	○		x	○	○	x	○	○
1.85:1	x	○	x	○	○	x	○	○	x	○	○
1.66:1	x	○	x	○	○		○	○	x	○	○
Grating	○	○	○	○	○	○	○	○	○	○	○
Box	○	○	○	○	○	○	○	○	○	○	○
User	○	○	○	○	○	○	○	○	○	○	○

Note: Aspect: (1) 4:3(V Full) (2) 16:9 (3) Actual Size (4) Blanking  
(5) Under Scan (6) Twice Size (7) SCOPE

### 3.5.4 Making Tally Settings

This section describes the Tally item on the menu.

#### ■ Basic Operation

1. Set the Function Select Switch to FUNC, press the MENU Switch, and display the Menu screen.
2. Choose **Tally** by pressing the +/- switches and then press the ENT Switch.
3. Choose the item to be changed by pressing the +/- switches and then press the ENT Switch to move down a level, or select and enter adjustment, and then press the ENT Switch to confirm.
4. Choose the item to be changed on the lower level by pressing the +/- switches and then press the ENT Switch to enter adjustment, and then press the ENT Switch to confirm.

Note: If the item to be changed is on an even lower level, press the ENT switch again to move down a level.

Note: The value being adjusted is not saved until the ENT Switch is pressed to confirm the entry. The value being adjusted is destroyed if you exit a menu before confirming it.

#### ■ MENU Hierarchical Screen Image

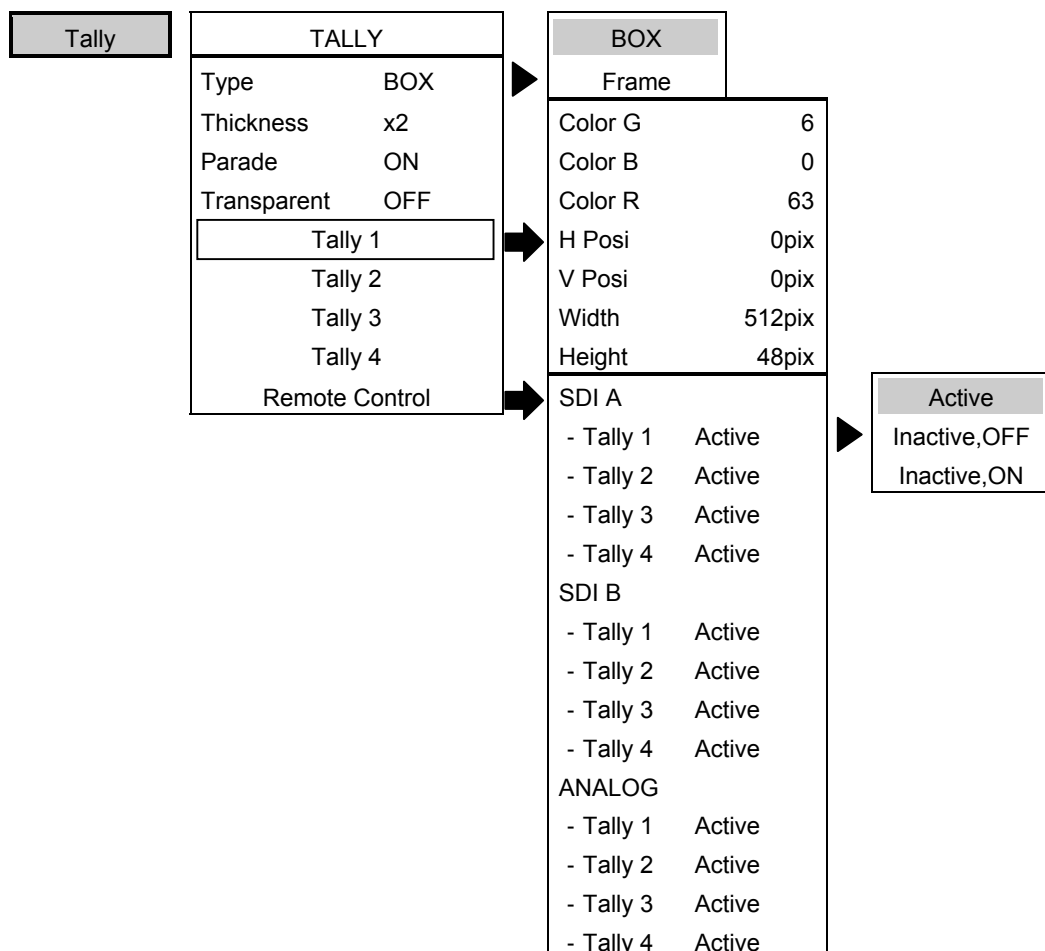

Note: The currently selected item is displayed in reverse text.

■ Detailed Descriptions of Each Item

Item	Description	Remarks
Type	Switches between Frame/Box for the Tally display method.	
Thickness	Adjusts the thickness of the frame tally.	
Parade	Switches whether or not to display with a superimposed frame tally.	If ON, a display with colors separated results. If OFF, a superimposed display results. In the case of a superimposed display, tally is displayed in the order of priority Tally 1 > Tally 2 > Tally 3.
Transparent	Switches between transparent/opaque for the tally background video.	Uses an externally connected device for the tally light. Usually lights when the externally connected device is ON. (* Supplement 2)
Tally 1	Makes detailed settings for Tally 1.	The color of each tally, box size, and display position can be adjusted. (* Supplement 1)
Tally 2	Makes detailed settings for Tally 2.	
Tally 3	Makes detailed settings for Tally 3.	
Tally 4	Makes detailed settings for Tally 4.	
Remote Control	Sets the tally lighting method.	Uses an externally connected device for the tally light. Usually lights when the externally connected device is ON. (* Supplement 2)

**Supplement 1** Items that can be set for each tally are as follows.

Item	Description
Color	Adjusts the tally color for each of G, B, and R.
H Posi	Adjusts the horizontal display position when using a box tally.
V Posi	Adjusts the vertical display position when using a box tally.
Width	Adjusts the horizontal size when using a box tally.
Height	Adjusts the vertical size when using a box tally.



**Supplement 2** Tally setting items are as follows.

Item		Description	Remarks	
SDI A	Tally 1	Sets ON/OFF for Tally 1 through Tally 4 when displaying the signal input to SDI IN CH A.	Active	Depends on the remote controller setting.
	Tally 2		Inactive,OFF	Forcibly turns the tally OFF.
	Tally 3		Inactive,ON	Forcibly turns the tally ON.
	Tally 4			
SDI B	Tally 1	Sets ON/OFF for Tally 1 through Tally 4 when displaying the signal input to SDI IN CH B.	Active	Depends on the remote controller setting.
	Tally 2		Inactive,OFF	Forcibly turns the tally OFF.
	Tally 3		Inactive,ON	Forcibly turns the tally ON.
	Tally 4			
ANALOG	Tally 1	Sets ON/OFF for Tally 1 through Tally 4 when displaying the signal input to COMPOSITE.	Active	Depends on the remote controller setting.
	Tally 2		Inactive,OFF	Forcibly turns the tally OFF.
	Tally 3		Inactive,ON	Forcibly turns the tally ON.
	Tally 4			

### 3.5.5 Making Audio Level Meter Settings

This section describes the Audio item on the menu.

#### ■ Basic Operation

1. Set the Function Select Switch to FUNC, press the MENU Switch, and display the Menu screen.
2. Choose **Audio** by pressing the +/- switches and then press the ENT Switch.
3. Choose the item to be changed by pressing the +/- switches and then press the ENT Switch to switch, or enter adjustment, and then press the ENT Switch to confirm.

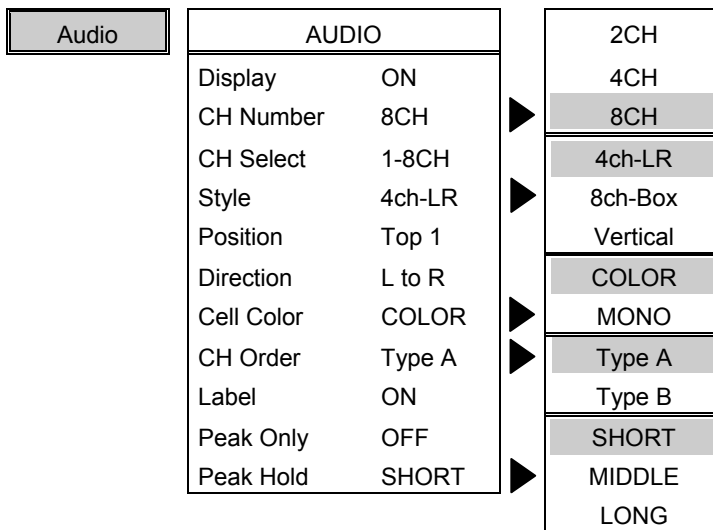

Note: The value being adjusted is not saved until the ENT Switch is pressed to confirm the entry. The value being adjusted is destroyed if you exit a menu before confirming it.

#### ■ MENU Hierarchical Screen Image



Note: The currently selected item is displayed in reverse text.

### ■ Detailed Descriptions of Each Item

Item	Description	Remarks	
<b>Display</b>	Switches whether to display/hide the audio level meter.	Audio level meter ON/OFF can also be switched using <b>Audio</b> under <b>DISPLAY</b> .  	
<b>CH Number</b>	Sets the number of channels to be displayed from among 2CH, 4CH, and 8CH.		
<b>CH Select</b>	Sets the channels to be displayed.	If 2CH is the number of channels to be displayed, select from among the pairs, 1-2CH, 3-4CH, 5-6CH, 7-8CH, 9-10CH, 11-12CH, 13-14CH, and 15-16CH. If 4CH is the number of channels to be displayed, select from among, 1-4CH, 5-8CH, 9-12CH, and 13-16CH, and if 8CH is the number of channels to be displayed, select from among 1-8CH and 9-16CH.	
<b>Style</b>	Sets the audio level meter display method.	4ch_LR	Displays the same channel on both left and right.
		8ch_Box	Displays all channels together.
		Vertical	Displays the same channel on both left and right. However, in this case only, level changes are oriented in the vertical direction. When the level increases, the meter changes by moving from the bottom of the screen to the top.
<b>Position</b>	Sets the audio level meter display position.	If 4ch_LR is selected for <b>Style</b> above, the display position can be chosen from one of six heights: Top1 through Top3 and Bottom1 through Bottom3. If 8ch_Box is selected, the display position can be chosen from one of four corners: upper left, upper right, lower left, and lower right. If Vertical is selected, the display position can be chosen from one of three heights: Top, Middle, and Bottom.	
<b>Direction</b>	Switches L to R/OUT to IN for the display format of the audio level meter.	L to R	The meter changes from left to right if the level increases.
		OUT to IN	The meter changes from the edge of the screen to the middle of the screen if the level increases.
<b>Cell Color</b>	Switches color display/monochrome display for the audio level meter.	For the coloration of cells of the audio level meter, see Section 4.7.	

CH Order	Switches Type A/Type B for the channel layout of the audio level meter.	Type A	If channels are displayed split left and right, display is made from the left of the screen in the order of lowest channel number. If all channels are being displayed together, display is made in order from the top.
		Type B	If channels are being displayed split left and right, display is made alternately on the left and right of the screen in order of lowest channel number. If all channels are being displayed together, display is made in order from the top.
Label	Switches display/hide for the numeric scale of the audio level meter.	Maintains the peak value for about 2 seconds.	
Peak Only	Switches display/hide for the current level of each channel.	ON:ON: Displays a peak level BOX and audio EN BOX. OFF: Displays a peak level BOX, current level BOX, and audio EN BOX.	
Peak Hold	Sets the time to maintain the peak value.	SHORT	Maintains the peak value for about 2 seconds.
		MIDDLE	Maintains the peak value for about 4 seconds.
		LONG	Maintains the peak value for about 8 seconds.

**Supplement 1**

Displays BTA S-006 B and SMPTE 272M-A standard specifications for the audio data. For details on the audio level meter, see Section 4.7.



**Supplement 2**

The audio meter level does not function when a composite signal is selected, because no audio is output.

### 3.5.6 Making Simple Waveform Display Settings

This section describes the Wave item on the menu.

#### ■ Basic Operation

1. Set the Function Select Switch to FUNC, press the MENU Switch, and display the Menu screen.
2. Choose **Wave** by pressing the +/- switches, and then press the ENT Switch.
3. Choose the item to be changed by pressing the +/- switches and then press the ENT Switch to switch, or enter adjustment, and then press the ENT Switch to confirm.

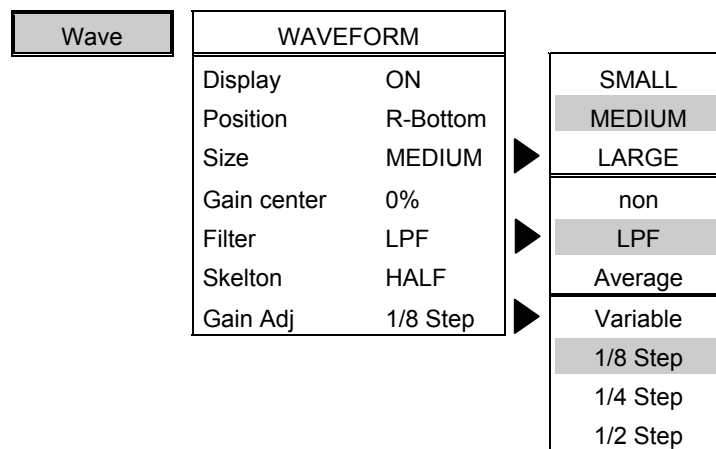

Note: The value being adjusted is not saved until the ENT Switch is pressed to confirm the entry. The value being adjusted is destroyed if you exit a menu before confirming it.

#### ■ MENU Hierarchical Screen Image



Note: The currently selected item is displayed in reverse text.

■ Detailed Descriptions of Each Item

Item	Description	Remarks	
Display	Switches display/hide for the simple waveform.	Simple waveform ON/OFF can also be switched using <b>Waveform</b> under <b>Display</b> .  	
Position	Sets the simple waveform display position. (* Supplement 1)	L-Top	Displays the simple waveform in the upper left.
		R-Top	Displays the simple waveform in the upper right.
		L-Bottom	Displays the simple waveform in the lower left.
		R-Bottom	Displays the simple waveform in the lower right.
Size	Simple waveform display size Switches among SMALL, MEDIUM, and LARGE.	If LARGE is selected, the display is full screen regardless of the <b>Position</b> setting.	
Gain Center	Switches display point 0%/100% when displaying an enlarged simple waveform.	0%	Displays the region around 0%. 
		100%	Displays the region around 100%.
Filter	Switches the simple waveform filter.	non	Displays without filter processing.
		LPF	Displays while applying a low-pass filter.
		Average	Displays with balancing over four pixels front and back.
Skelton	Switches the degree to which the video image is shown through the simple waveform.	non	Uses black for the mini-wave background.
		HALF	The mini-wave background is semi-transparent.
		FULL	The mini-wave background is transparent.
Gain Adj	Sets the number of steps for the gain adjustment value.	Variable	Allows adjustment in units of 0.01.
		1/8 Step	Allows adjustment in units of 0.125. (Values are displayed by rounding off the third digit after the decimal point.)
		1/4 Step	Allows adjustment in units of 0.25.
		1/2 Step	Allows adjustment in units of 0.50.

**Supplement 1** **Position** is linked with the **Position** item under **Vector**.

### 3.5.7 Making Vector Display Settings

This section describes the Vector item on the menu.

#### ■ Basic Operation

1. Set the Function Select Switch to FUNC, press the MENU Switch, and display the Menu screen.
2. Choose **Vector** by pressing the +/- Switches, and then press the ENT Switch.
3. Choose the item to be changed by pressing the +/- switches and then press the ENT Switch to switch, or enter adjustment, and then press the ENT Switch to confirm.

Note: The value being adjusted is not saved until the ENT Switch is pressed to confirm the entry. The value being adjusted is destroyed if you exit a menu before confirming it.

#### ■ MENU Hierarchical Screen Image

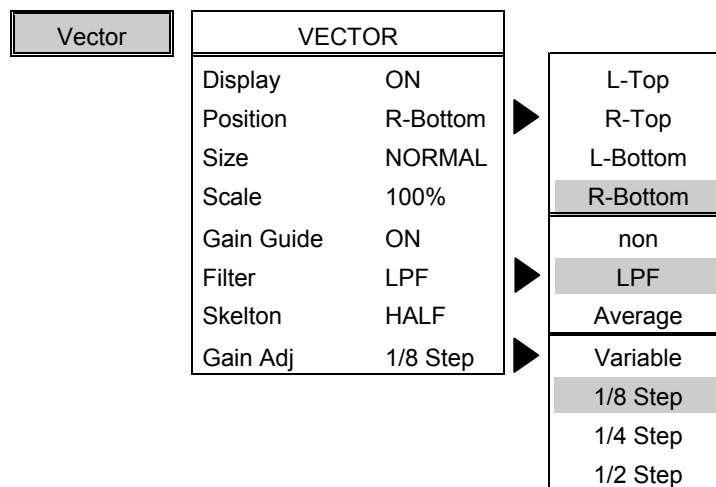

Note: The currently selected item is displayed in reverse text.

■ Detailed Descriptions of Each Item

Item	Description	Remarks	
<b>Display</b>	Switches display/hide for the vector.	Vector ON/OFF can also be switched using <b>Vector</b> under <b>Display</b> . 	
<b>Position</b>	Sets the vector display position. (* Supplement 1)	L-Top	Displays the vector in the upper left.
		R-Top	Displays the vector in the upper right.
		L-Bottom	Displays the vector in the lower left.
		R-Bottom	Displays the vector in the lower right.
<b>Size</b>	Vector display size Switches between NORMAL/LARGE.	If LARGE is selected, the display is full screen regardless of the <b>Position</b> setting.	
<b>Scale</b>	Switches between 100%/75% for the color bar scale box.		
<b>Gain Guide</b>	Switches between display/hide for the gain guide.		
<b>Filter</b>	Switches the vector filter.	non	Displays without filter processing.
		LPF	Displays while applying a low-pass filter.
		Average	Displays with balancing over four pixels front and back.
<b>Skelton</b>	Switches the degree to which the video image is shown through the vector.	non	Uses black for the mini-wave background
		HALF	The mini-wave background is semi-transparent.
		FULL	The mini-wave background is transparent.
<b>Gain Adj</b>	Sets the number of steps for the gain adjustment value.	Variable	Allows adjustment in units of 0.01.
		1/8 Step	Allows adjustment in units of 0.125. (Values are displayed by rounding off the third digit after the decimal point.)
		1/4 Step	Allows adjustment in units of 0.25.
		1/2 Step	Allows adjustment in units of 0.50.

**Supplement 1** **Position** is linked with the **Position** item under **Wave**.



### 3.5.8 Making ID Settings

This section describes the ID item on the menu.

#### ■ Basic Operation

1. Set the Function Select Switch to FUNC, press the MENU Switch, and display the Menu screen.
2. Choose **ID** by pressing the +/- Switches, and then press the ENT Switch.
3. Choose the item to be changed using the +/- Switches, and press the ENT Switch to switch, or move down a level.
4. Choose the item to be changed on the lower level by pressing the +/- switches and then press the ENT Switch to enter adjustment, and then press the ENT Switch to confirm.

Note: If the item to be changed is on an even lower level, press the ENT switch again to move down a level.

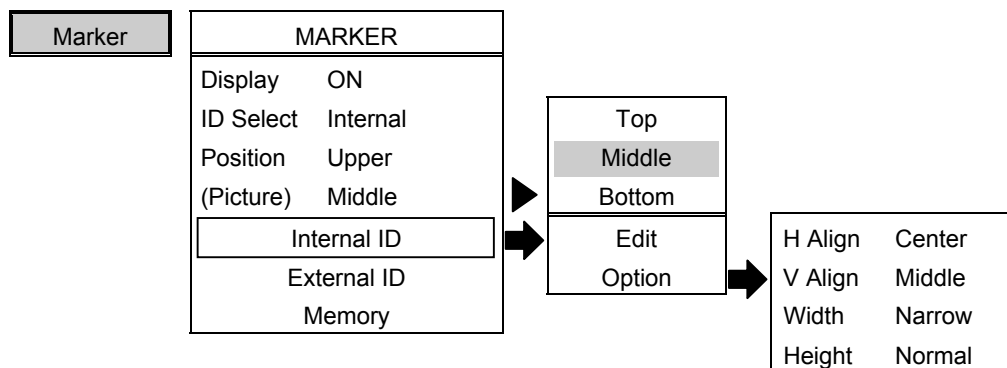

Note: The value being adjusted is not saved until the ENT Switch is pressed to confirm the entry. The value being adjusted is destroyed if you exit a menu before confirming it.

#### ■ MENU Hierarchical Screen Image



Note: The currently selected item is displayed in reverse text.

## ■ Detailed Descriptions of Each Item

Item	Description	Remarks	
<input type="checkbox"/> Display	Switches display/hidden for the ID.	 	
<input type="checkbox"/> ID Select	Displays the setting source for the ID to be displayed.		
<input type="checkbox"/> Position	Sets the ID display area.	Upper	Displays the ID at the top. (* Supplement 1)
		Lower	Displays the ID at the bottom. (* Supplement 1)
<input type="checkbox"/> (Picture)	Sets the video image display area.	Top	Displays the video image shifted slightly up. (* Supplement 1)
		Middle	Displays the video image in the center. (* Supplement 1)
		Bottom	Displays the video image shifted slightly down. (* Supplement 1)
<input type="checkbox"/> Internal ID	The ID setting is made on the DM-3105 main unit.	<p>The internal ID setting is used.</p> <p>It is possible to set the display characters, display position, and character spacing. (* Supplement 2)</p> <p>Japanese cannot be used in the case of an internal ID setting.</p>	
<input type="checkbox"/> External ID	Cannot be selected.	This function is used only with models that support external ID control.	
<input type="checkbox"/> Memory	Cannot be selected.	This function is used only with models that support external ID control.	

**Supplement 1** The position specification for  Position and  (Picture) is linked in some cases.

If Top or Bottom is selected for  (Picture), the position specification for  Position is automatically changed to Lower if Top is selected, and to Upper if Bottom is selected. Also, if the position specification for  Position is changed after Top or Bottom has been selected for  (Picture), the position specification for  (Picture) is also changed accordingly. If Middle has been selected for  (Picture), the ID display position will conform to the  Position specification.

**Supplement 2** Items that can be set using **Internal ID** are as follows.

Item	Description	Remarks	
<b>Edit</b>	Sets the text to be displayed.	Text can be changed one letter at a time. Up to ten characters consisting of upper or lowercase alphabetic characters, numeric characters, and basic symbols can be displayed. (* Supplement 1-1) Japanese cannot be used.	
<b>Option</b>	<b>H Align</b>	Adjusts the horizontal display position of the ID text.	Left Displays the ID text justified to the left.
		Center Displays the ID text in the center.	
		Right Displays the ID text justified to the left.	
	<b>V Align</b>	Adjusts the vertical display position of the ID text.	Top Displays the ID text at the top.
			Middle Displays the ID text in the center.
			Bottom Displays the ID text at the bottom.
	<b>Width</b>	Adjusts the ID text character width.	Narrow Displays using a narrow character width.
			Normal Displays using a standard character width.
			Wide Displays using a wide character width.
	<b>Height</b>	Adjusts the vertical size of ID text characters.	Small Displays ID text with a small character height.
			Normal Displays ID text with a standard character height.
			Large Displays ID text with a large character height.
Extra Displays ID text with a character height even larger than Large.			

■ **Supplement 2-1: Characters that can be used are as follows.**

	!	"	#	\$	%	&		(	)	*	+	,	-	.	/
0	1	2	3	4	5	6	7	8	9	:	;	<	=	>	?
@	A	B	C	D	E	F	G	H	I	J	K	L	M	N	O
P	Q	R	S	T	U	V	W	X	Y	Z	[	\	]	^	_
	a	b	c	d	e	f	g	h	i	j	k	l	m	n	o
p	q	r	s	t	u	v	w	x	y	z	{		}	~	

### 3.5.9 Making Screen Display and Layout Settings

This section describes the Display item on the menu.

#### ■ Basic Operation

1. Set the Function Select Switch to FUNC, press the MENU Switch, and display the Menu screen.
2. Choose Display by pressing the +/- Switches, and then press the ENT Switch.
3. Choose the item to be changed using the +/- Switches, and press the ENT Switch to switch, or move down a level.
4. Choose the item to be changed on the lower level by pressing the +/- switches and then press the ENT Switch to enter adjustment, and then press the ENT Switch to confirm.

Note: If the item to be changed is on an even lower level, press the ENT switch again to move down a level.





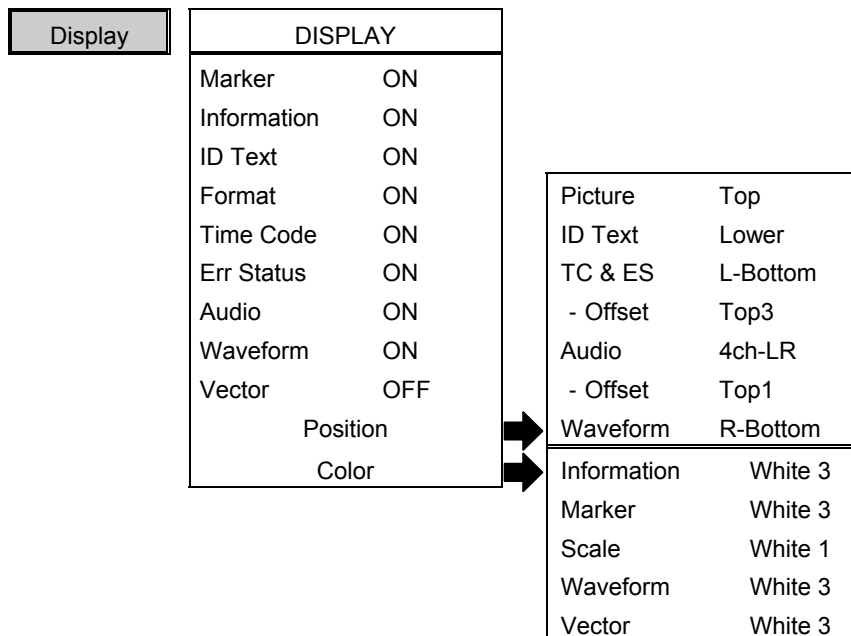









Note: The value being adjusted is not saved until the ENT Switch is pressed to confirm the entry. The value being adjusted is destroyed if you exit a menu before confirming it.

#### ■ MENU Hierarchical Screen Image



Note: The currently selected item is displayed in reverse text.

### ■ Detailed Descriptions of Each Item

Item	Description	Remarks
<b>Maker</b>	Switches ON/OFF for markers.	 
<b>Information</b>	Switches ON/OFF for all display items set under <b>ID Text</b> through <b>Audio</b> below.	 
<b>ID Text</b>	Switches display/hide for the input signal ID.	 
<b>Format</b>	Switches display/hide for the format.	If turned ON, display is made for only about three seconds after the format is changed.
<b>Time Code</b>	Switches display/hide for the time code.	VITC, LTC, and other codes conforming to the ARIB STD-B4 Ver. 2.0 standard are displayed for the time code. The time code display does not function when a composite signal is selected.  
<b>Err Status</b>	Switches display/hide for the error status.	Display of subtitle data ON/OFF, CRC error/EDH error count, Time, and Last are included in error status.
<b>Audio</b>	Switches whether to display/hide the audio level meter.	Audio level meter ON/OFF can also be switched using <b>Display</b> under <b>Audio</b> .  
<b>Waveform</b>	Switches display/hide for the simple waveform.	Simple waveform ON/OFF can also be switched using <b>Display</b> under <b>Wave</b> . Also, turning <b>Vector</b> ON automatically turns <b>Wave</b> OFF.  
<b>Vector</b>	Switches display/hide for the vector.	Simple waveform ON/OFF can also be switched using <b>Display</b> under <b>Vector</b> . Also, if <b>Wave</b> is turned ON, <b>Vector</b> is automatically turned OFF.  

Position	Sets the display position for the above items.	Picture	Sets the video image display area. (* Supplement 1)
		ID Text	Sets the ID display area. (* Supplement 1)
		TC & ES	Sets the display position for time code and error status. (* Supplement 2)
		-Offset	Sets the display position for time code and error status. (* Supplement 2)
		Audio	Sets the audio level meter display method. (* Supplement 3)
		-Offset	Sets the audio level meter display position. (* Supplement 3)
		Waveform	Sets the display position of the simple waveform or vector. (* Supplement 4)
Color	Sets the display color for the above items.	Information	Sets the display color for information. Information refers to all information other than cell coloration of the audio level meter, simple waveform, and markers.
		Maker	Sets the display color for markers.
		Scale	Sets the display color for the simple waveform or vector scale.
		Waveform	Sets the simple waveform display color.
		Vctor	Sets the vector display color.

**Supplement 1** The relationship between the video display area and ID display area is as follows. (\* Supplement 1-1)

Item	Description	Remarks	
Picture	Sets the video image display area.	Top	Displays the video image shifted slightly up.
		Middle	Displays the video image in the center.
		Bottom	Displays the video image shifted slightly down.
ID Text	Sets the ID display area.	Upper	Displays the ID at the top.
		Lower	Displays the ID at the bottom.

- Supplement 1-1:** The position specification for **Position** and **Picture** is linked in some cases.

If Top or Bottom is selected for **Picture**, the position specification for **Position** is automatically changed to Lower if Top is specified, and to Upper if Bottom is specified.

Also, if the position specification for **Position** is changed after Top or Bottom has been selected for **Picture**, the position specification for **Picture** is also changed accordingly.

If Middle has been selected for **Picture**, the ID display position will conform to the **Position** specification.

**Supplement 2** Sets the display position for the time code and error status together as a group.

The display positions that can be set for the time code and error status are as follows.

L-Top: Displays the information in the upper left. The height of the display position can be chosen from one of three offsets.

R-Top: Displays the information in the upper right. The height of the display position can be chosen from one of three offsets.

L-Bottom: Displays the information in the lower left. The height of the display position can be chosen from one of three offsets.

R-Bottom: Displays the information in the lower right. The height of the display position can be chosen from one of three offsets.

**Supplement 3** The display positions that can be set for the audio level meter are as follows.

Item	Description	Remarks	
Audio	Sets the audio level meter display method.	4ch_LR	Displays the same channel on both left and right.
		8ch_Box	Displays all channels together.
		Vertical	Displays the same channel on both left and right. However, in this case only, level changes are oriented in the vertical direction. When the level increases, the meter changes by moving from the bottom of the screen to the top.
Offset	Sets the audio level meter display position.	<p>If 4ch_LR is selected for <b>Audio</b> above, the display position can be chosen from one of six heights: Top1 through Top3 and Bottom1 through Bottom3.</p> <p>If 8ch_Box is selected, the display position can be chosen from one of four corners: upper left, upper right, lower left, and lower right.</p> <p>If Vertical is selected, the display position can be chosen from one of three heights: Top, Middle, and Bottom.</p>	

**Supplement 4**

The display positions that can be set for a simple waveform or vector are: upper left, upper right, lower left, and lower right.

### 3.5.10 Assigning Functions to Front Switches

This section describes the Switch item on the menu.

#### ■ Basic Operation

1. Set the Function Select Switch to FUNC and press the MENU Switch.
2. Choose Switch by pressing the +/- Switches, and then press the ENT Switch.
3. Choose the switch whose function is to be changed by pressing the +/- Switches, and then press the ENT switch.
4. Choose the function to change to by pressing the +/- Switches, and then press the ENT Switch.

Supplement

Functions can be assigned to the four switches F1 through F4.  
 It is possible to assign the same function to different switches.  
 The function name of the function currently assigned appears in reverse text.  
 To exit from the list of function names, press the ESC Switch.

#### ■ MENU Hierarchical Screen Image

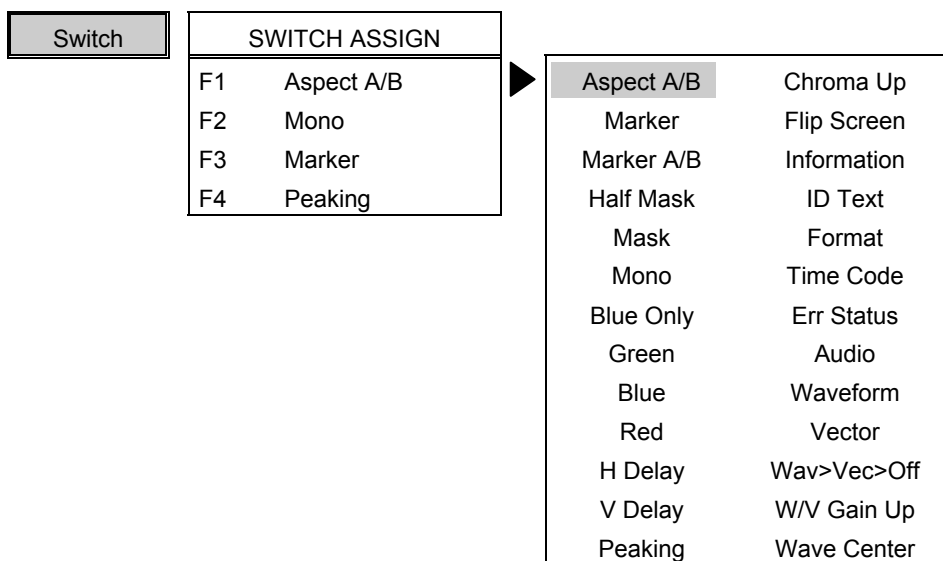

Note: The currently selected item is displayed in reverse text.



**Supplement 1** Items that can be set using **SWITCH ASSIGN** are as follows.

Item	Description	Remarks
Aspect A/B	Switches the aspect ratio between Type A and Type B.	
Marker	Switches ON/OFF for markers.	
Marker A/B	Switches Type A/B for markers.	This can be switched even if markers are being hidden.
Half Mask	Switches half-mask ON/OFF.	
Mask	Switches between mask ON/OFF.	
Mono	Switches between a monochrome and color display.	
Blue Only	Switches between a blue only display and color display.	
Green	Switches between ON/OFF for the green component of video.	
Blue	Switches between ON/OFF for the blue component of video.	
Red	Switches between ON/OFF for the red component of video.	
H Delay	Switches the horizontal delay ON/OFF.	
V Delay	Switches vertical delay ON/OFF.	
Peaking	Switches between ON/OFF for peaking.	
Chroma Up	Switches between ON/OFF for the multiplication of the chroma signal value.	
Flip Screen	Rotates the display screen 180°.	
Information	Switches ON/OFF for all display items set under <b>Display</b> .	Settings that can be turned ON/OFF all at once are: ID Text, Format, Time Code, Err Status, and Audio.
ID Text	Switches display/hide for the input signal ID.	
Format	Switches display/hide for the format.	If turned ON, display is made for only about three seconds after the format is changed.
Time Code	Switches display/hide for the time code.	
Err Status	Switches display/hide for the error status.	
Audio	Switches whether to display/hide the audio level meter.	
Waveform	Switches display/hide for the simple waveform.	
Vector	Switches display/hide for the vector.	
Wav>Vec>Off	Switches in the order: wave display → vector display → hide → waveform display.	
W/V Gain Up	Switches x1/x5 for the waveform or vector gain.	
Wave Center	Switches 0%/100% for the waveform display center.	

### 3.5.11 Making Remote Controller Settings

This section describes the Remote item on the menu.

#### ■ Basic Operation

1. Set the Function Select Switch to FUNC and press the MENU Switch.
2. Choose  by pressing the +/- Switches, and then press the ENT Switch.
3. Choose the remote controller operation method or item by pressing the +/- Switches, and then press the ENT Switch.
4. To change setting items, choose the item to be assigned by pressing the +/- Switches again, and then press the ENT Switch to confirm.

#### Supplement

If the remote controller is not being used, set  through  to .

The function name of the function currently assigned appears in reverse text.

The remote controller operation method and recommended switch assignments are as follows.

When  is Selected...Slide switch recommended,

Assigns function status to each of open and short.

When  is Selected...Slide switch recommended,

The function switches the moment that open goes to short or short goes to open.

When  is Selected...Push switch recommended,

The function is switched the moment open goes to short.

#### Caution

If one remote controller that has been set has chosen the same item as another remote controller, the setting is enabled for the remote controller set last. The setting for the remote controller for which the same item was chosen earlier is set to , and no function is assigned.

## ■ MENU Hierarchical Screen Image

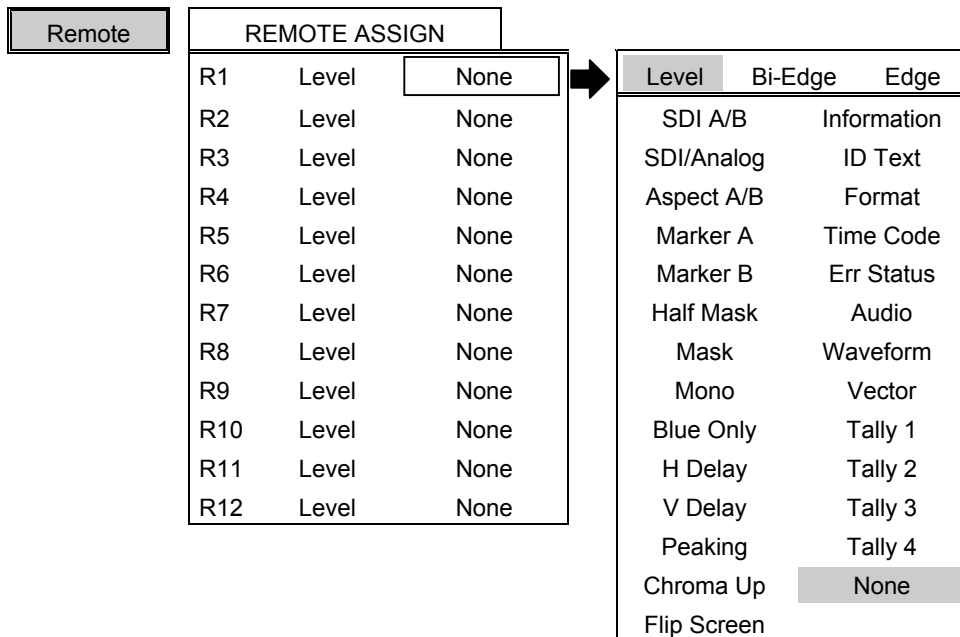

Note: The currently selected item is displayed in reverse text.

**Supplement 1** Items that can be set using **REMOTE ASSIGN** are as follows.

Item	Description	Remarks
SDI A/B	Switches CH A/CH B for HD/SD SDI IN.	
SDI/Analog	Switches HD/SD SDI IN/COMPOSITE.	
Aspect A/B	Switches the aspect ratio between Type A and Type B.	
Marker A	Switches ON/OFF for markers.	
Marker B	Switches Type A/B for markers.	
Half Mask	Switches half-mask ON/OFF.	
Mask	Switches between mask ON/OFF.	
Mono	Switches between a monochrome and color display.	
Blue Only	Switches between a blue only display and color display.	
H Delay	Switches the horizontal delay ON/OFF.	
V Delay	Switches vertical delay ON/OFF.	
Peaking	Switches between ON/OFF for peaking.	
Chroma Up	Switches between ON/OFF for the multiplication of the chroma signal value.	
Flip Screen	Rotates the display screen 180°.	

Information	Switches ON/OFF for all display items set under <u>Display</u> .	Settings that can be turned ON/OFF all at once are: ID Text, Format, Time Code, Err Status, and Audio.
ID Text	Switches display/hide for the input signal ID.	
Format	Switches display/hide for the format.	If turned ON, display is made for only about three seconds after the format is changed.
Time Code	Switches display/hide for the time code.	
Err Status	Switches display/hide for the error status.	
Audio	Switches whether to display/hide the audio level meter.	
Waveform	Switches display/hide for the simple waveform.	
Vector	Switches display/hide for the vector.	
Tally 1	Switches display/hide for Tally 1.	
Tally 2	Switches display/hide for Tally 2.	
Tally 3	Switches display/hide for Tally 3.	
Tally 4	Switches display/hide for Tally 4.	
None	Assigns nothing.	

### 3.5.12 Saving, Loading and Renaming Settings and Destroying Saved Settings

This section describes the Load item on the menu.

#### ■ Basic Operation

1. Set the Function Select Switch to FUNC, press the MENU Switch, and display the Menu screen.
2. Choose **Load** by pressing the +/- Switches and then press the ENT Switch.
3. Choose the item to be worked with by pressing the +/- Switches, and then press the ENT Switch.
4. Choose a number by pressing the +/- Switches on the lower level, and then press the ENT Switch.
5. To rename, choose the character to be changed by pressing the +/- Switches and then pressing the ENT Switch, and choose the character to change to by pressing the +/- Switches and then pressing the ENT Switch to confirm.

Supplement

Move to the Save item by holding down the MENU Switch.

#### ■ MENU Hierarchical Screen Image

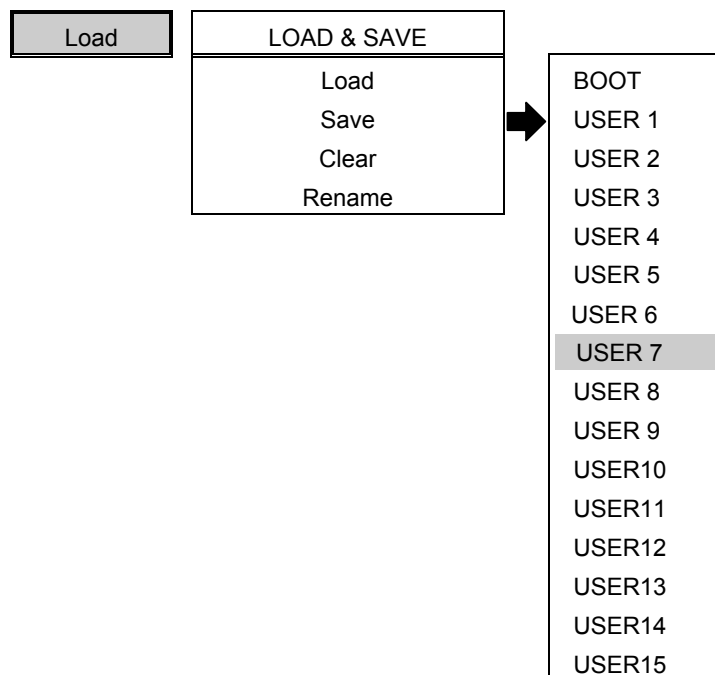

Note: Saved settings are displayed in reverse text.

## ■ Detailed Descriptions of Each Item

Item	Description	Remarks
Load	Loads a saved setting.	
Save	Saves the current setting.	
Clear	Destroys a saved setting.	Destroys rename data used under <input type="text" value="Rename"/> .
Rename	Changes the setting save name.	Text can be changed one letter at a time. Up to eight characters consisting of upper or lowercase alphabetic characters, numeric characters, and basic symbols can be displayed. (* Supplement 2)

### Supplement 1

With all items,  is displayed during operations. Do not turn off the power while  is being displayed.

If power is turned OFF during operations, all saved data will be destroyed, and default settings will be set the next time power is turned on.

### Supplement 2

The characters that can be used are as follows.

	!	"	#	\$	%	&		(	)	*	+	,	-	.	/
0	1	2	3	4	5	6	7	8	9	:	;	<	=	>	?
@	A	B	C	D	E	F	G	H	I	J	K	L	M	N	O
P	Q	R	S	T	U	V	W	X	Y	Z	[	\	]	^	_
	a	b	c	d	e	f	g	h	i	j	k	l	m	n	o
p	q	r	s	t	u	v	w	x	y	z	{		}	~	

### 3.5.13 Restoring Defaults

This section describes the Reset item on the menu.

#### ■ Basic Operation

1. Set the Function Select Switch to FUNC, press the MENU Switch, and display the Menu screen.
2. Choose **RESET CALL** by pressing the +/- Switches, and then press the ENT Switch.
3. Choose the item to be worked with by pressing the +/- Switches, and then press the ENT Switch to initialize.

#### ■ MENU Hierarchical Screen Image

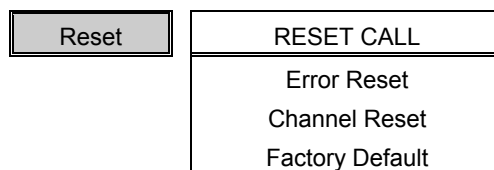

#### ■ Detailed Descriptions of Each Item

Item	Description	Remarks
Error Reset	Resets the error count.	Does not reset the elapsed time (Time).
Channel Reset	Initializes setting values for the currently selected channel.	The error count, elapsed time (Time), and settings shared by all channels are not reset. Furthermore, setting values saved in <b>LOAD &amp; SAVE</b> as user data are also not initialized.
Factory Default	Initializes setting values for all channels.	Does not reset the elapsed time (Time). Furthermore, setting values saved in <b>LOAD &amp; SAVE</b> as user data are also not initialized.

**Supplement** For settings initialized by **Channel Reset** and **Factory Default** see Section 4.9.

### 3.5.14 Making Detailed LCD Settings

This section describes the Quality item on the menu.

#### ■ Basic Operation

1. Set the Function Select Switch to FUNC, press the MENU Switch, and display the Menu screen.
2. Choose **PICTURE QUALITY** by pressing the +/- Switches, and then press the ENT Switch.
3. Choose the item to be worked with by pressing the +/- Switches, and then press the ENT Switch to confirm.

#### ■ MENU Hierarchical Screen Image

Quality	PICTURE QUALITY	
	Color Temperature	6500K
	G-Bright	0.0%
	B-Bright	0.0%
	R-Bright	0.0%
	G-Contrast	100.0%
	B-Contrast	100.0%
	R-Contrast	100.0%
	G-Gamma	2.20
	B-Gamma	2.20
	R-Gamma	2.20



### ■ Detailed Descriptions of Each Item

Item	Description	Remarks
Color Temperature	Switches the color temperature.	Color temperature can be selected from one of three choices: 5500K, 6500K, and 9300K.
G-Bright	Adjust the G brightness value.	The adjustable range is -50.00 to +50.00%.
B-Bright	Adjust the B brightness value.	
R-Bright	Adjust the R brightness value.	
G-Contrast	Adjust the G contrast value.	The adjustable range is 0.0 to 200.0%.
B-Contrast	Adjust the B contrast value.	
R-Contrast	Adjust the R contrast value.	
G-Gamma	Adjust the G gamma value.	The adjustable range is 1.00 to 4.00.
B-Gamma	Adjust the B gamma value.	
R-Gamma	Adjust the R gamma value.	

#### Supplement

Setting values are held for G brightness, B brightness, R brightness, G contrast, B contrast, R contrast, G gamma, B gamma, and R gamma depending on the color temperature.

For details on each adjustment, see Section 4.5.

### 3.5.15 Making Basic Settings for the Main Unit

This section describes the HW Set item on the menu.

#### ■ Basic Operation

1. Set the Function Select Switch to FUNC and press the MENU Switch.
2. Choose **HW Set** by pressing the +/- Switches, and then press the ENT Switch.
3. Choose the item to be changed using the +/- Switches, and press the ENT Switch to switch, or move down a level.
4. Choose the item to change to by pressing the +/- Switches, and then press the ENT Switch to confirm, or choose the item to be changed on the lower level, and then press the ENT Switch.
5. To change an item on the lower level, choose the numeric value to change to using the +/- Switches, and then press the ENT Switch to confirm.

#### ■ MENU Hierarchical Screen Image

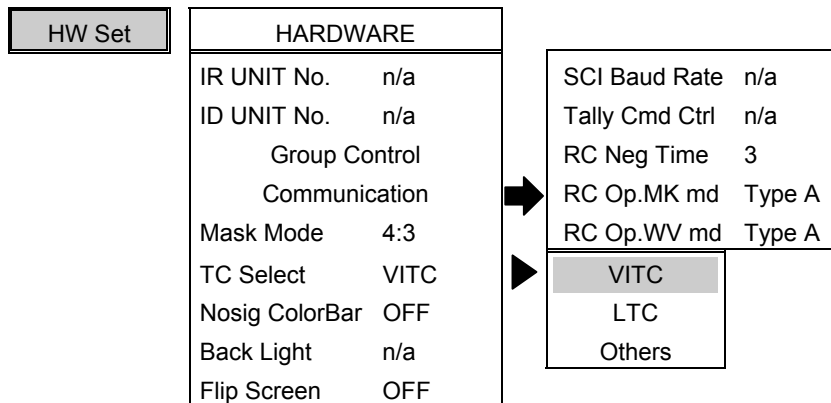

Note: The currently selected item is displayed in reverse text.

Note: n/a is displayed for items whose function is disabled.

### ■ Detailed Descriptions of Each Item

Item	Description	Remarks
IR UNIT No.	Cannot be selected.	This function is only for models that support an infrared remote controller.
ID UNIT No.	Cannot be selected.	This function is used only with models that support external ID control.
Group Control	Cannot be selected.	This function is only for models that support an infrared remote controller or external ID control.
Communication	Performs external communications and makes communication settings.	(* Supplement)
Mask Mode	Switches 4:3/Marker for the mask area.	4:3 When display is made at 16:9, the 4:3 area contained within it is masked or half-masked.
		Marker The area set using markers is or half-masked. There are seven types of markers that can be used with this setting: 4:3, 13:9, 14:9, 2.35:1, 1.85:1, 1.66:1, and User.
TC Select	Switches among VITC, LTC and Others for the time code standard.	
Nosig ColorBar	Switches display/hide for the color bar when no signal is input.	When ON, an internally color bar is displayed when no signal is input.
Back Light	Cannot be selected.	
Flip Screen	Performs external communications and makes communication settings.	

**Supplement** Items that can be set under **Communication** are as follows.

Item	Description	Remarks
SCI Baud Rate	Cannot be selected.	This function is used only with models that support external ID control.
Tally Cmd Ctrl	Cannot be selected.	This function is used only with models that support external ID control.
RC Neg Time	Sets the time from power on until remote control settings are loaded.	

RC Op.MK md	Switches Type A/Type B for the remote control Marker A and Marker B functions.	Type A	Switches ON/OFF of marker type A for Marker A and ON/OFF of marker type B for Marker B.
		Type B	Switches marker ON/OFF for Marker A. Switches marker type Type A/Type B for Marker B.
RC Op.VK md	Switches Type A/Type B for the remote control Waveform and Vector functions.	Type A	Switches simple waveform ON/OFF for Waveform, and vector ON/OFF for Vector.
		Type B	Switches simple waveform or vector ON/OFF for Waveform. Switches simple waveform or vector ON/OFF for Vector.

# 4

## Main Specifications

### 4.1 Input Formats

Format		Frame Rate (Hz)	Active Line per Frame	Total Line Per Frame	Line Frequency (kHz)	Samples per Active Line	Samples per Total Line	Scanning *1	*2
1080i/60 (*3)	1080i/59.94	30/1.001	1080	1125	33.72	1920	2200	i	(1)
	1080sF/29.97							sF	(3)
1080p/30	1080i/60	30	1080	1125	33.75	1920	2200	i	(1)
	1080sF/30							sF	(3)
1080p/30	1080p/29.97	30/1.001	1080	1125	33.72	1920	2200	p	(2)
	1080p/30	30	1080	1125	33.75	1920	2200	p	
1080sF/25 (1080i/50)	1080sF/25	25	1080	1125	28.13	1920	2640	sF	(3)
	1080i/50							i	(2)
1080p/25	1080p/25	25	1080	1125	28.13	1920	2640	p	(2)
1080sF/24	1080sF/23.98	24/1.001	1080	1125	26.97	1920	2750	sF	(3)
	1080sF/24	24	1080	1125	27.00	1920	2750	sF	
1080p/24	1080p/23.98	24/1.001	1080	1125	26.97	1920	2750	p	(2)
	1080p/24	24	1080	1125	27.00	1920	2750	p	
720p/60	720p/59.94	60/1.001	720	750	44.96	1280	1650	p	(4)
	720p/60	60	720	750	45.00	1280	1650	p	
720p/50	720p/50	50	720	750	36.00	1280	1980	p	(4)
720p/30	720p/29.97	30/1.001	720	750	22.48	1280	3300	p	(4)
	720p/30	30	720	750	22.50	1280	3300	p	
720p/25	720p/25	25	720	750	18.75	1280	3960	p	(4)
720p/24	720p/23.98	24/1.001	720	750	17.98	1280	4125	p	(4)
	720p/24	24	720	750	18.00	1280	4125	p	
525i/60	525i/59.94	60/1.001	487	525	15.73	720	858	i	(5)
625i/50	625i/50	50	576	625	15.63	720	864	i	(6)

\*1 Abbreviated symbols used with Scanning

i = Interlace

sF = Segmented Frame

p = Progressive

\*2 Supported Standards

(1) Conforms to BTA S-001B/2B/4B, (2) Conforms to SMPTE 274M,

(3) Conforms to RP 211-2000, (4) Conforms to SMPTE 296M,

(5) Conforms to SMPTE 259M, (6) Conforms to ITU-R BT.601-5

\*3 If the input signal is 1035i/60 format, the signal is processed as a 1080i/60 format signal.

## 4.2 Input Signal Systems

Input Specifications	SDI Input Specifications	Specifications
SDI Input	HDTV	NRZI SDI signal conforming to BTA S-004B and SMPTE 292M
	SDTV	NRZI SDI signal conforming to SMPTE 259M Note: However, the guaranteed reception distance is 100m.
	Automatic input format, field (frame) frequency tracking	

Composite Input Specifications	Specifications
NTSC (525/60)	Conforms to SMPTE 170M
PAL (625/50)	ITU-R624-4 (PAL-N/PAL-M not supported)

## 4.3 Display System

Display System	Specifications		
Liquid crystal	TFT liquid crystal		
Display colors	16.7 million colors, 8-bit		
Contrast ratio	600:1		
Response time	25ms (Typ: full white 90% ⇒ full black 10% + full black 10% ⇒ full white 90%)		
Viewing angle	Top/bottom: 170°, Left/right: 170°		
Brightness	300cd/m <sup>2</sup> (max)		
Screen size	5 inch		
Resolution	800(H) × 480(V) Pixels		
Video image area	Aspect notation	Display size	
		HDTV	SDTV
	4:3(V Full)	800(H) × 480(V) Pixels	640(H) × 480(V) Pixels
	16:9	800(H) × 450(V) Pixels	800(H) × 450(V) Pixels
	Actual Size	800(H) × 480(V) Pixels	
	Twice Size		800(H) × 480(V) Pixels
	Blanking/Under Scan	750(H) × 422(V) Pixels	600(H) × 450(V) Pixels
SCOPE	800(H) × 340(V) Pixels		
Pixel pitch	0.135(W) × 0.135(H) mm		

## 4.4 Headphone Output

Maximum output	10mW±5% (32Ω/1kHz)
Frequency response	100Hz to 20kHz (0dB to -3dB) An audio signal is output when 48-kHz embedded audio is superimposed on the SDI signal.

## 4.5 Adjustment Values

### ■ Brightness

The adjustable range for the brightness signal offset level is -50.00 to +50.00%.  
The same is true for G brightness, B brightness, and R brightness.

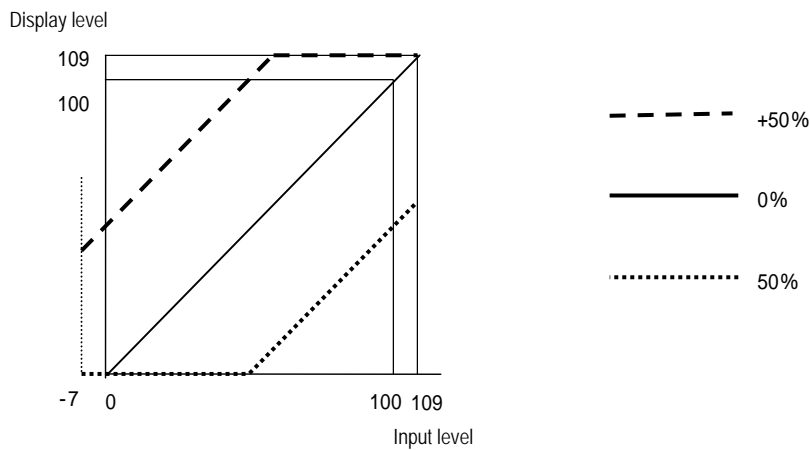



## ■ Contrast

The adjustable range for the brightness signal level is 0.0 to 200.0%.

The same is true for G contrast, B contrast, and R contrast.

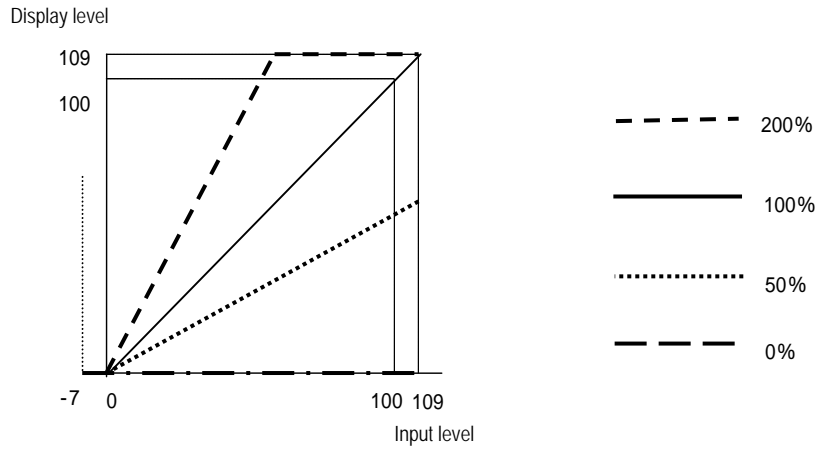

## ■ Chroma, Pb(Cb), Pr(Cr)

The adjustable range for the color difference signal level is 0.0 to 200.0%.

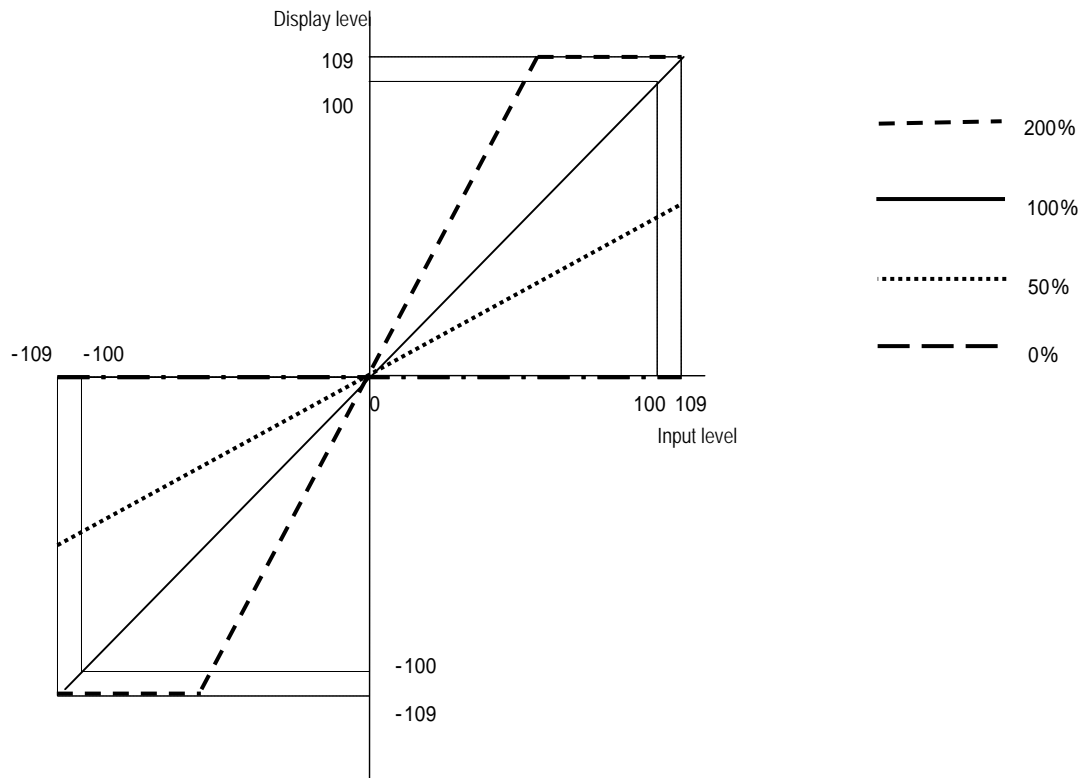

## 4.6 Aspect Ratio

- **4:3**

SD input only: Displayed so the video image area fills the LCD screen in the vertical direction.

- **V Full**

HD input only: Displayed so the video image area fills the LCD screen in the vertical direction.  
(The video image is cut in the horizontal direction.)

- **16:9**

During HD input: The video image area is displayed at 16:9.

During SD input: The 4:3 aspect video image area is stretched horizontally for display at 16:9.

- **Actual Size**

HD input only: Each pixel in the input signal is displayed at a 1-to-1 correspondence to a pixel on the LCD screen.

Note: Interlaced signals are twice as large in the vertical direction.

- **Twice Size**

SD input only: Each pixel in the input signal is displayed using 8 pixels (2x4) on the LCD screen.

- **Blanking**

The video image is reduced and displayed including blanking.

- **Under Scan**

The video image is reduced and video is displayed without displaying blanking.

- **SCOPE**

HD input only: The image stretched horizontally like Cinemascope and displayed.

## 4.7 The Audio Level Meter

An audio level meter conforming to audio standards BTA S-006B and SMPTE272M-A is displayed.

### 4.7.1 Audio Level and Cell Coloration

The audio level and coloration of each cell are as follows.

CELL No.	Audio level	Coloration	
		Color	Mono
0	0dB	Red	White
1	Greater than or equal to -1dB, but less than 0dB	Orange	Gray 192 (*1)
2	Greater than or equal to -2dB, but less than -1dB	Orange	Gray 192 (*1)
3	Greater than or equal to -3dB, but less than -2dB	Orange	Gray 192 (*1)
4	Greater than or equal to -4dB, but less than -3dB	Orange	Gray 192 (*1)
5	Greater than or equal to -5dB, but less than -4dB	Orange	Gray 192 (*1)
6	Greater than or equal to -6dB, but less than -5dB	Orange	Gray 192 (*1)
7	Greater than or equal to -7dB, but less than -6dB	Orange	Gray 192 (*1)
8	Greater than or equal to -8dB, but less than -7dB	Orange	Gray 192 (*1)
9	Greater than or equal to -9dB, but less than -8dB	Orange	Gray 192 (*1)
10	Greater than or equal to -10dB, but less than -9dB	Orange	Gray 192 (*1)
11	Greater than or equal to -11dB, but less than -10dB	Orange	Gray 192 (*1)
12	Greater than or equal to -12dB, but less than -11dB	Orange	Gray 192 (*1)
13	Greater than or equal to -13dB, but less than -12dB	Orange	Gray 192 (*1)
14	Greater than or equal to -14dB, but less than -13dB	Orange	Gray 192 (*1)
15	Greater than or equal to -15dB, but less than -14dB	Orange	Gray 192 (*1)
16	Greater than or equal to -16dB, but less than -15dB	Orange	Gray 192 (*1)
17	Greater than or equal to -17dB, but less than -16dB	Orange	Gray 192 (*1)
18	Greater than or equal to -18dB, but less than -17dB	Orange	Gray 192 (*1)
19	Greater than or equal to -19dB, but less than -18dB	Yellow	White
20	Greater than or equal to -20dB, but less than -19dB	Yellow	White
21	Greater than or equal to -21dB, but less than -20dB	Green	Gray 160 (*2)

\*1 Gray where G:192, B:192, R:192

\*2 Gray where G:160, B:160, R:160

CELL No.	Audio level	Coloration	
		Color	Mono
22	Greater than or equal to -22dB, but less than -21dB	Green	Gray 160 (*2)
23	Greater than or equal to -23dB, but less than -22dB	Green	Gray 160 (*2)
24	Greater than or equal to -24dB, but less than -23dB	Green	Gray 160 (*2)
25	Greater than or equal to -25dB, but less than -24dB	Green	Gray 160 (*2)
26	Greater than or equal to -26dB, but less than -25dB	Green	Gray 160 (*2)
27	Greater than or equal to -27dB, but less than -26dB	Green	Gray 160 (*2)
28	Greater than or equal to -28dB, but less than -27dB	Green	Gray 160 (*2)
29	Greater than or equal to -29dB, but less than -28dB	Green	Gray 160 (*2)
30	Greater than or equal to -30dB, but less than -29dB	Green	Gray 160 (*2)
31	Greater than or equal to -32dB, but less than -30dB	Green	Gray 160 (*2)
32	Greater than or equal to -34dB, but less than -32dB	Green	Gray 160 (*2)
33	Greater than or equal to -35dB, but less than -34dB	Green	Gray 160 (*2)
34	Greater than or equal to -37dB, but less than -35dB	Green	Gray 160 (*2)
35	Greater than or equal to -39dB, but less than -37dB	Green	Gray 160 (*2)
36	Greater than or equal to -40dB, but less than -39dB	Green	Gray 160 (*2)
37	Greater than or equal to -42dB, but less than -40dB	Green	Gray 160 (*2)
38	Greater than or equal to -44dB, but less than -42dB	Green	Gray 160 (*2)
39	Greater than or equal to -45dB, but less than -44dB	Green	Gray 160 (*2)
40	Greater than or equal to -47dB, but less than -45dB	Green	Gray 160 (*2)
41	Greater than or equal to -49dB, but less than -47dB	Green	Gray 160 (*2)
42	Greater than or equal to -52dB, but less than -49dB	Green	Gray 160 (*2)
43	Greater than or equal to -53dB, but less than -52dB	Green	Gray 160 (*2)
44	Greater than or equal to -56dB, but less than -53dB	Green	Gray 160 (*2)
45	Greater than or equal to -60dB, but less than -56dB	Green	Gray 160 (*2)
46	Greater than or equal to -63dB, but less than -60dB	Green	Gray 160 (*2)
47	Audio ON/OF	Green	Gray 160 (*2)

\*1 Gray where G:192, B:192, R:192

\*2 Gray where G:160, B:160, R:160

### 4.7.2 Display Format and Cell Coloration

■ **Display format: When displayed left-to-right (4ch\_LR, 8ch\_Box type)**

The CELL NO. (see item 4.7.1) is as given in the figure below. The audio level meter varies from left to right as the audio level increases.

Ex.: When CH Number: 8CH, CH Select: 1-8CH, and Style: 4ch\_LR have been selected

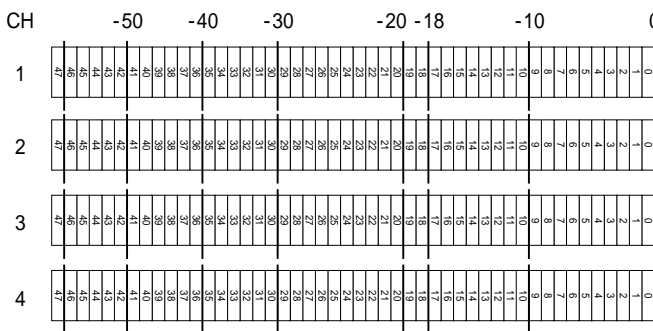

Level meter on left of screen

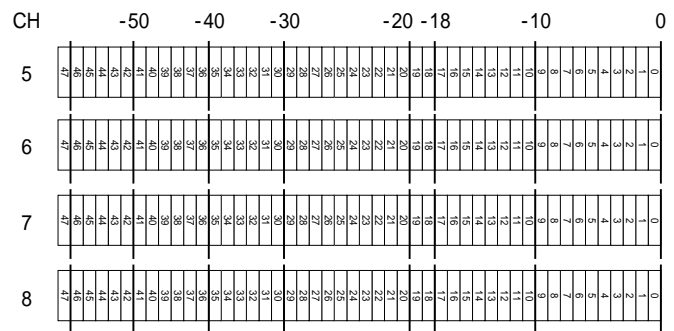

Level meter on right of screen

■ **Display format: when OUT to IN is selected (4ch\_LR, 8ch\_Box type)**

The CELL NO. (see item 4.7.1) is as given in the figure below. The audio level meter on the left of the screen varies from left to right as the audio level increases. The audio meter on the right of the screen varies from right to left as the audio level increases.

Ex.: When CH Number: 8CH, CH Select: 1-8CH, and Style: 4ch\_LR have been selected

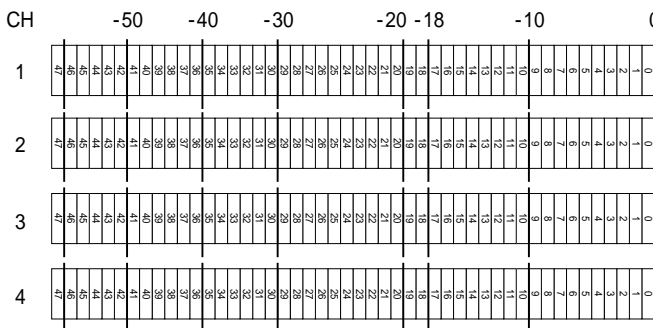

Level meter on left of screen

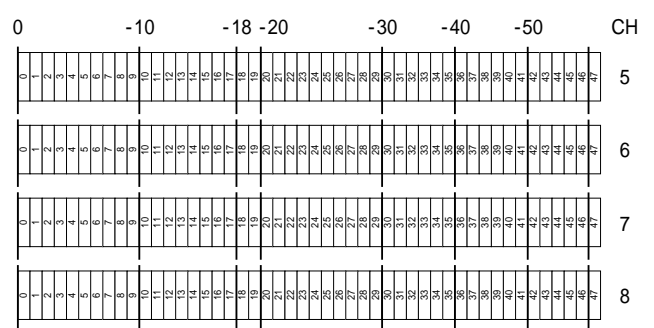

Level meter on right of screen

■ **Display format: When Vertical type is selected**

The CELL NO. (see item 4.7.1) is as given in the figure below. The audio level meter varies from bottom to top as the audio level increases.

Ex.: When CH Number: 8CH and CH Select: 1-8CH have been selected

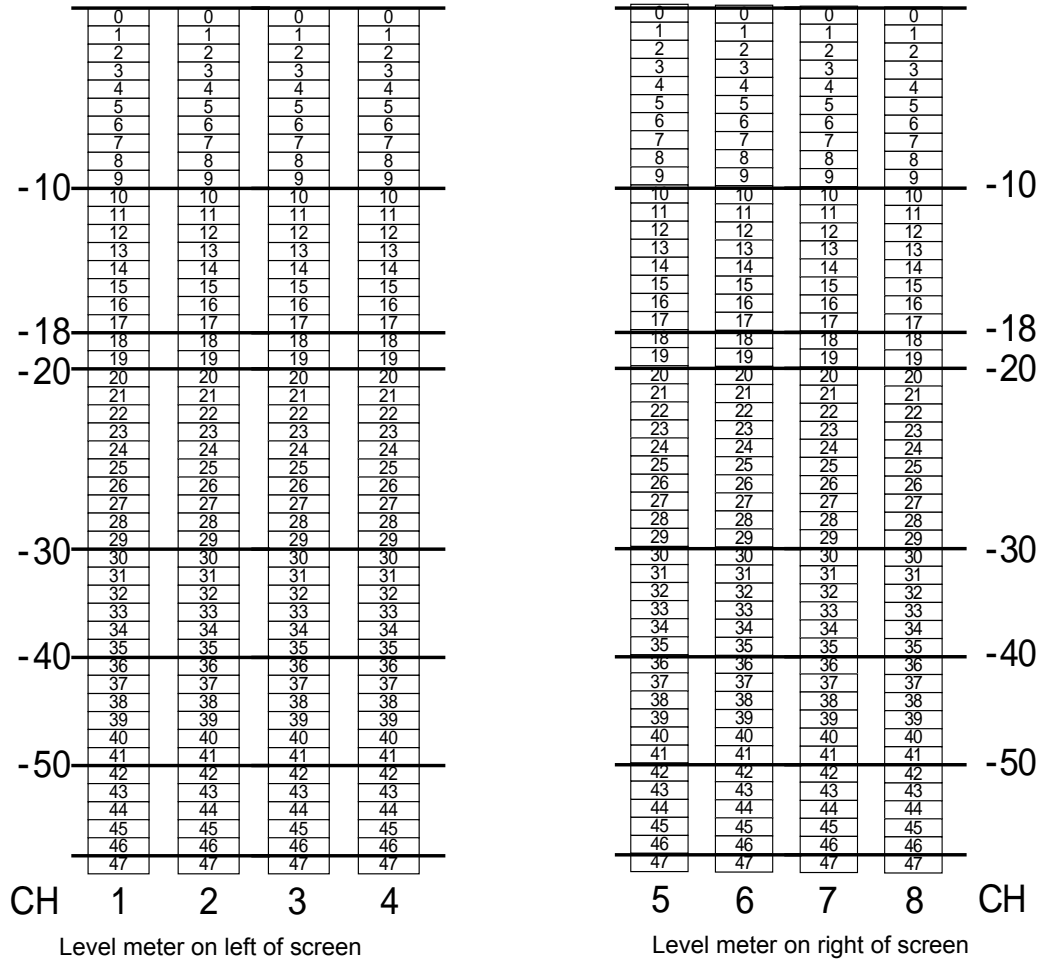

## 4.8 Contact Type Remote Controllers

### 4.8.1 Operation Example

#### About Edge Operations

Edge operations execute switch commands when a control signal is confirmed to transit from LOW to HIGH.

Ex.: Switching SDI\_A/SDI\_B

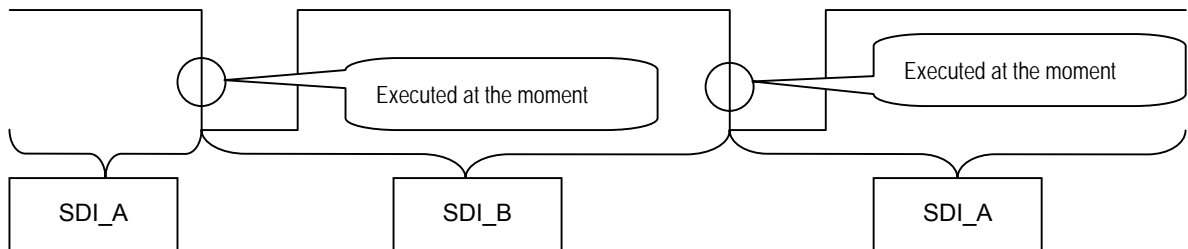

#### About Level Operations

With level operations, a setting value is assigned to each signal status (HIGH or LOW).

Ex.: Switching SDI\_A/SDI\_B

When SDI-A is assigned to HIGH and SDI-B is assigned to LOW

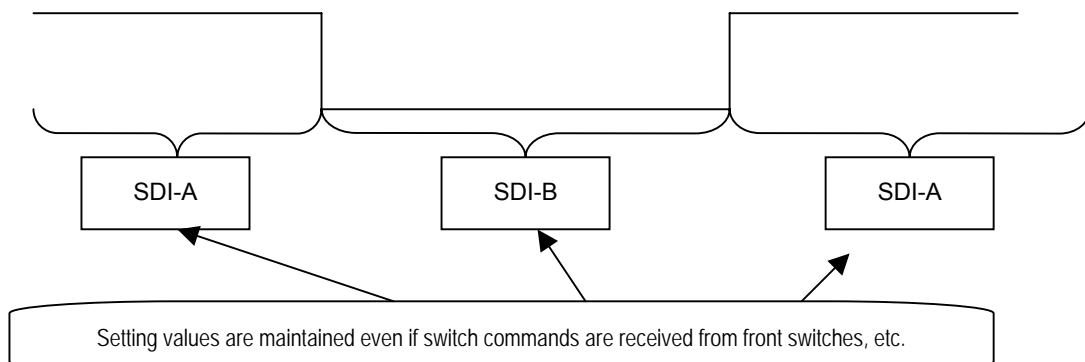

## About Dual Edge Operations

With dual edge operations, the setting value changes at both the rising edge and falling edge of a signal.

Ex.: Switching SDI\_A/SDI\_B

When LOW -> HIGH is assigned for SDI-A and HIGH -> LOW is assigned for SDI-B

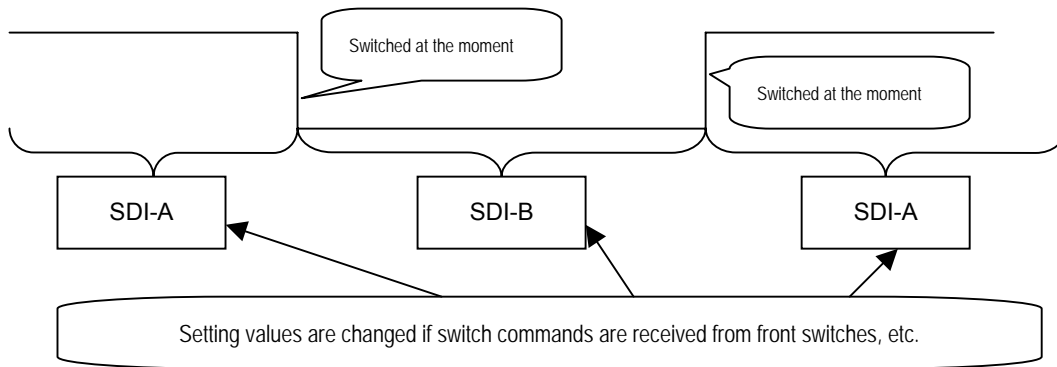

## Precautions

- When using edge operations, input an active pulse of at least 50 ms.



## 4.8.2 Setting Values During Level Operations

Display	Function	Status during level operations	
		Open (1)	Make (0)
SDI A/B	Switching SDI A/B	SDI_A	SDI_B
SDI/Analog	Switching SDI <-> composite	SDI	Composite
Aspect A/B	TYPEA/TYPEB	TYPE_A	TYPE_B
Marker A	A Type marker ON/OFF	OFF	ON
Marker B	B Type marker ON/OFF	OFF	ON
Half Mask	Half-mask ON/OFF	OFF	ON
Mask	Mask ON/OFF	OFF	ON
MONO	Switching MONO/Color	Color	MONO
Blue Only	ON/OFF	OFF	ON
H Delay	ON/OFF	OFF	ON
V Delay	ON/OFF	OFF	ON
Peaking	ON/OFF	ON	OFF
Chroma Up	Chroma Up function ON/OFF	OFF	ON
Flip Screen	Image rotate function ON/OFF	OFF	ON
Information	Controls the display of the five items given below	Display	Hide
ID Text	Display/hide	Display	Hide
Format	Display/hide	Display	Hide
Time Code	Display/hide	Display	Hide
Err Status	Display/hide	Display	Hide
Audio	Display/hide	Display	Hide
Waveform	Display/hide simple waveform	Display	Hide
Vector	Display/hide vector	Display	Hide
TALLY1 (*1)	Display/hide	Hide	Display
TALLY2 (*1)	Display/hide	Hide	Display
TALLY3 (*1)	Display/hide	Hide	Display
TALLY4 (*1)	Display/hide	Hide	Display
Non		-	-

(\*1) This function can be used only with level operations. Other functions (Edge, Bi-Edge) cannot be selected.

(\*2) This function can only be selected with models that support external ID control.

## 4.9 Setting Values at Time of Initialization

Various setting values are set as given below when the DM-3105 is shipped from the factory and when the unit is initialized.

### 4.9.1 Setting Items by Channel

The setting values given below represent items for which SDI A, SDI B, and COMPOSITE are set separately. These values are initialized if either "Channel Reset" or "Factory Default" are executed.

Setting Item	Setting and Adjustable Range	Initial value		
		SDI A	SDI B	COMPOSITE
Channel ID		SDI A	SDI B	COMPOSITE
Brightness	-50.0 to +50.0%	0.0%	0.0%	0.0%
Contrast	0.0 to 200.0%	100.0%	100.0%	100.0%
Pb(Cb)	0.0 to 200.0%	100.0%	100.0%	100.0%
Pr(Cr)	0.0 to 200.0%	100.0%	100.0%	100.0%
Hue	-179.0 to 180.0°	0.0°	0.0°	0.0°
Peaking Level	0 to 100	0	0	0
Peaking	ON/OFF	ON	ON	ON
Filter	ON/OFF	ON	ON	ON
Mono	ON/OFF	OFF	OFF	OFF
Blue Only	ON/OFF	OFF	OFF	OFF
Green	ON/OFF	ON	ON	ON
Blue	ON/OFF	ON	ON	ON
Red	ON/OFF	ON	ON	ON
Color Space	YPbPr/GBR/XYZ	YPbPr	YPbPr	YPbPr
H Delay	ON/OFF	OFF	OFF	OFF
V Delay	ON/OFF	OFF	OFF	OFF
Chroma Up	ON/OFF	OFF	OFF	OFF
Tally 1 Remote Control	Active / Inactive-OFF / Inactive-ON	Active	Active	Active
Tally 2 Remote Control	Active / Inactive-OFF / Inactive-ON	Active	Active	Active
Tally 3 Remote Control	Active / Inactive-OFF / Inactive-ON	Active	Active	Active
Tally 4 Remote Control	Active / Inactive-OFF / Inactive-ON	Active	Active	Active
Volume	0 to 255	128	128	N/A
L_CH	1 to 16CH	1CH	1CH	N/A
R_CH	1 to 16CH	2CH	2CH	N/A

## 4.9.2 Shared Setting Items

The setting values given below represent items shared by SDI A, SDI B, and COMPOSITE.

These setting values are not initialized when "Factory Default" is executed unless all channel setting values are initialized.

Setting Item		Setting and Adjustable Range		Initial value			
Current CH		SDI A/SDI B/COMPOSITE		SDI A			
ID Select		Internal		Internal			
Internal ID		H Align	Center/Right/Left	Center			
		V Align	Top/Middle/Bottom	Middle			
		Width	Narrow/Normal/Wide	Narrow			
		Height	Normal/Large/Extra	Normal			
External ID	Area1	Size	N/A	N/A			
		Area2	Style	N/A	N/A		
			Area3	Edge	N/A	N/A	
	Inverse	N/A		N/A			
	H Align	N/A		N/A			
	V Align	N/A		N/A			
	Char Color	N/A		N/A			
	Layout	Edge Color	N/A	N/A			
			Setting	N/A	N/A		
			Side Space	N/A	N/A		
		L:R	N/A	N/A			
				Area1	Area2	Area3	
		H Pos	N/A	N/A	N/A	N/A	
		V Pos	N/A	N/A	N/A	N/A	
		Width	N/A	N/A	N/A	N/A	
		Height	N/A	N/A	N/A	N/A	
		Option	Font	N/A	N/A		
	Pitch		N/A	N/A			
	Boldweight		N/A	N/A			
	Condence		N/A	N/A			

Setting Item		Setting and Adjustable Range	Initial value	
Color Temperature		9300K/6500K/5500K	6500K	
G-Brightness		-50.0 to +50.0%	Chapter 7. 0.0%	
B-Brightness		-50.0 to +50.0%	0.0%	
R-Brightness		-50.0 to +50.0%	0.0%	
G-Contrast		0.0 to 200.0%	100.0%	
B-Contrast		0.0 to 200.0%	100.0%	
R-Contrast		0.0 to 200.0%	100.0%	
G-Gamma		1.00 to 4.00	2.20	
B-Gamma		1.00 to 4.00	2.20	
R-Gamma		1.00 to 4.00	2.20	
Marker	Display	ON/OFF	OFF	
	Select	Type A / Type B	Type A	
	Type A Select	Frame, Center, 95%, 93%, 88%, 80%, 4:3, 13:9, 14:9, 2.35:1, 1.85:1, 1.66:1, Grating, User, Box	Frame, Center	
	Type A Select	Frame, Center, 95%, 93%, 88%, 80%, 4:3, 13:9, 14:9, 2.35:1, 1.85:1, 1.66:1, Grating, User, Box	4:3	
	Box	H posi	0 to 799pix	130pix
		V posi	0 to 479pix	38pix
		Width	1 to 800pix	540pix
		Height	1 to 480pix	405pix
	User	H	0 to 100%	85%
		V	0 to 100%	85%
	Thickness		×1/×2/×3/×4	×1
Information		ON/OFF	ON	
ID Text		ON/OFF	ON	
Format		ON/OFF	ON	
Time Code		ON/OFF	ON	
Err Status		ON/OFF	ON	
Audio		ON/OFF	ON	
Waveform		ON/OFF	ON	
Vector		ON/OFF	OFF	

Setting Item		Setting and Adjustable Range	Initial value			
Position	Picture	Top/Middle/Bottom	Middle			
	ID Text	Upper/Lower	Upper			
	TC & ES	L/R - Top/Bottom	L-Bottom			
	- Offset	Offset 1 to 3	Offset 1			
	Audio	4ch-LR / 8ch-Box / Vertical	4ch-LR			
	- Offset	4ch_LR: Top1 to 3, Bottom1 to 3 8ch_Box: L/R - Top/Bottom Vertical: Top/Middle/Bottom	Top 1			
	Waveform	L-Top/R-Top/L-Bottom/R-Bottom	R-Bottom			
Color	Information	G: 0-3, B:0-3, R:0-3 for a total of 63 colors (Excluding black)	White3 (G:3, B:3, R:3)			
	Marker	G: 0-3, B:0-3, R:0-3 for a total of 64 colors	White3 (G:3, B:3, R:3)			
	Scale	G: 0-3, B:0-3, R:0-3 for a total of 63 colors (Excluding black)	White1 (G:1, B:1, R:1)			
	Waveform	Red/Blue/Green/White 1 to 4	White3			
	Vector	Red/Blue/Green/White 1 to 4	White3			
Aspect	Type	TYPE A/TYPE B	TYPE A			
	A-HD	V Full/16:9/Actual Size/Blanking/ Under Scan/Scope	16:9			
	A-SD	4:3/16:9/ Twice Size/Blanking/Under Scan	4:3			
	B-HD	V Full/16:9/Actual Size/Blanking/ Under Scan/Scope	Under Scan			
	B-SD	4:3/16:9/ Twice Size/Blanking/Under Scan	16:9			
Tally	Type	Box/Frame	Box			
	Thickness	×1 to ×8	×2			
	Parade	ON/OFF	ON			
	Transparent	ON/OFF	OFF			
			Tally1	Tally2	Tally3	Tally4
	Color	G,B,R : 0 ~ 63	G:0, B:0, R:63	G:63, B:0, R:0	G:31, B:0, R:63	G:0, B:0, R:63
	H position	0 to 799pix	0pix	400pix	0pix	400pix
	V position	0 to 479pix	0pix	0pix	465pix	465pix
	Width	1 to 800pix	400pix	400pix	400pix	400pix
	Height	1 to 480pix	15pix	15pix	15pix	15pix

Setting Item		Setting and Adjustable Range	Initial value
Half Mask		ON/OFF	OFF
Mask		ON/OFF	OFF
Waveform	Size	SMALL/MEDIUM/LARGE	MEDIUM
	G Cent	0%/100%	0%
	Gain	0.01 to 7.99	1.00
Vector	Size	NORMAL/LARGE	NORMAL
	Scale	100%/75%	100%/75%
	G Guide	ON/OFF	ON
	Gain	0.01 to 7.99	1.00
Waveform	Filter	LPF/AVERAGE/non	LPF
Vector	Skelton	HALF/FULL/non	HALF
	Gain Adj	Variable / 1/8 Step / 1/4 Step / 1/2 Step	1/8 Step
Audio	CH Num	2CH/4CH/8CH	8CH
	CH Select	2CH:1-2CH,3-4CH, to 15-16CH 4CH:1-4CH,5-8CH,9-12CH,13-16CH 8CH:1-8CH,9-16CH	1-8CH
	Direction	L to R/OUT to IN	L to R
	Cell Color	COLOR/MONO	COLOR
	CH Order	Type A/Type B	Type A
	Label	ON/OFF	ON
	Peak Only	ON/OFF	OFF
	Peak Hold	SHORT/MIDDLE/LONG	SHORT
Phone Mute		ON/OFF	OFF
Switch Assign	F1	Aspect A/B, Marker, Marker A/B, Half Mask, Mask, Mono, Blue Only, Green, Blue, Red,	Aspect A/B
	F2	H Delay, V Delay, Peaking, Chroma Up, Flip Screen , Information, ID Text, Format,	Mono
	F3	Time Code, Err Status, Audio, Waveform,	Marker
	F4	Vector, Wav>Vec>Off , W/V Gain Up, Wave Center	Peaking

Setting Item		Setting and Adjustable Range	Initial value
Remote * (Where * is R1 through R12)	State	Level/Bi-Edge/Edge	Level
	Assign	SDI A/B, SDI/Analog, Aspect A/B, Marker A, Marker B, Half Mask, Mask, Mono, Blue Only, H Delay, V Delay, Peaking, Chroma Up, Flip Screen , Information, ID Text, Format, Time Code, Err Status, Audio, Waveform, Vector, Tally1, Tally2, Tally3, Tally4, Non	Non
Mask Mode		4:3/Marker	4:3
Color Bar		ON/OFF	OFF
NTSC Setup		7.5IRE/OFF	OFF
Flip Screen		ON/OFF	OFF

### 4.9.3 Automatically Saved Items

The setting values given below represent items shared by SDI A, SDI B, and COMPOSITE.

These setting items are not initialized even if Factory Default is executed.

Setting Item	Setting and Adjustable Range	Initial value
IR Unit No.	N/A	N/A
ID Unit No.	N/A	N/A
Group-IR Group Ctrl	N/A	N/A
Group-IR Group No.	N/A	N/A
Group-ID Group Ctrl	N/A	N/A
Group-ID Group No.	N/A	N/A
Group-ID Response	N/A	N/A
Comm-SCI Baud rate	N/A	N/A
Comm-Tally cmd Ctrl	N/A	N/A
Comm-RC NegTime	0 to 10	3
Comm-RC Op.Mk Mode	Type A/Type B	Type A
Comm-RC Op.WV Mode	Type A/Type B	Type A
Save Data Name		BOOT, USER 1 to 15

#### 4.9.4 Resetting the Error Count and Elapsed Time

The status values given below are initialized if "Error Reset" or "Factory Default" are executed.  
They are not initialized if "Channel Reset" is executed.

Status	Initial value	Remarks
CRC,EDH	0000000	
Last	00:00:00	Audio Err and CRC, EDH elapsed time

Note: Subtitles and Time are not initialized.



## 4.10 General Specifications

**Table 4.1 DM-3105 (Main Unit) Operating Environment and Ratings**

Operating temperature range	0 to 40°C
Storage temperature range	-10 to 60°C
Operating humidity range	30 to 80%RH (at an ambient temperature of 0 to 40°C and without condensation)
Storage humidity range	10 to 90%RH (at an ambient temperature of 0 to 40°C and without condensation)
Rated voltage	8 to 18 V DC
Power consumption (main unit)	8W (Typ) (main unit only)
Liquid crystal brightness lifetime	50,000 hours (half-life for liquid crystal brightness)(*)
External dimensions	142(W) x 88(H) x 42(D) (not including protruding parts)
Weight	Approx. 0.7 Kg (main unit only)

\* The liquid crystal lifetime is an estimated value, not a guaranteed one.

**Table 4.2 Operating Environment and Ratings for the Supplied AC/DC Adaptor**

Rated output voltage	12V±5%	
Rated output current	5.0A	
Maximum power output	60W	
Input voltage	Rating: 100-240 V AC	
Input frequency	Rating: 47-63Hz	
Output plug polarity	Pin 1	GND
	Pin 2	Chapter 8. NC
	Pin 3	NC
	Pin 4	+12V

## 4.11 External View

### 4.11.1 DM-3105 External View (Main Unit)

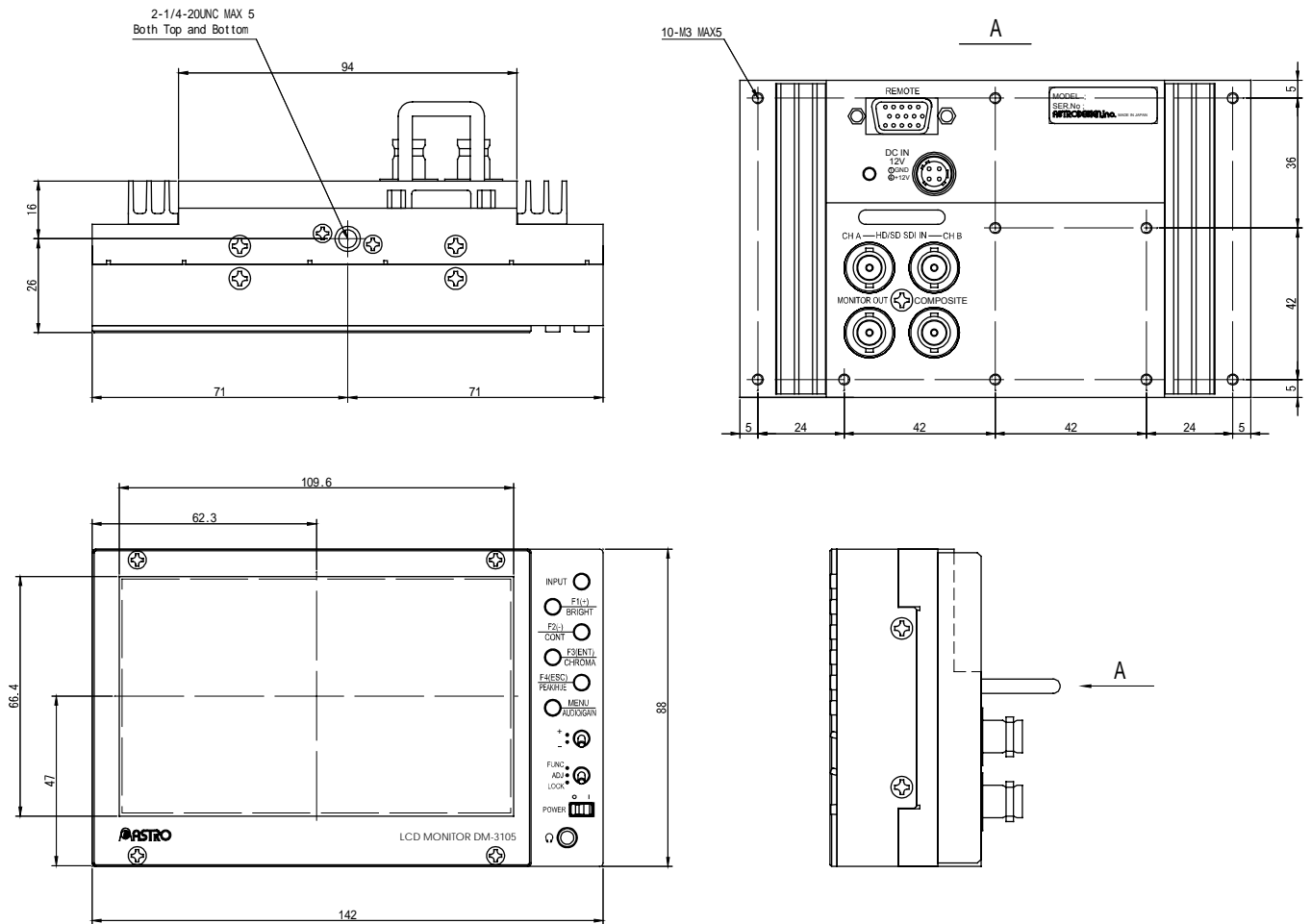

# 5

## Accessories and Options

### 5.1 Accessories

DM-3105 Instruction Manual (this manual)	1 copy
AC/DC adaptor	1 pc.
Canon-Camera Connector Conversion Cable	1 pc.

### 5.2 Options

Brackets for rack mounting, etc. have been prepared as options for the DM-3105 liquid crystal unit (this unit). Options are released frequently, so be sure to contact our sales representative for the latest information.



# 6

## Maintenance, etc.

### If the unit does not function normally

Symptom	Check Point
The video images is not displayed normally	<ul style="list-style-type: none"> <li>• Are the <b>Color Space</b> (YPbPr/GBR/XYZ) settings correct?</li> </ul>
Front switches do not work	<ul style="list-style-type: none"> <li>• Is the Function Select Switch locked?</li> </ul>
The remote controller does not work	<ul style="list-style-type: none"> <li>• Check the operation method of the remote controller. Is the Level, Bi-Edge, Edge selection correct?</li> <li>• Is the ENABLE_RMT pin (Pin 5) connected to GND?</li> <li>• Check the RC Neg Time setting under <b>HW Set</b> and <b>Communication</b>. After startup, remote controller input is ignored until a specified number of seconds have elapsed.</li> </ul>
Menu settings and setting value have changed Settings cannot be made on the menu	<ul style="list-style-type: none"> <li>• Check the operation method of the remote controller. Check the setting values for RC1 though RC12. (See Item 3.5.10 and Section 4.8) In the case of level settings, it is sometimes not possible to change settings on the menu in order to maintain setting values according to the level.</li> </ul>
No time code is displayed.	<ul style="list-style-type: none"> <li>• DID:260h and SDID:260h are the only time codes supported by this unit as standard. No other standards (such as RP196 or SMPTE291M) are supported.</li> </ul>
Power does not turn on	<ul style="list-style-type: none"> <li>• First, turn off the power, wait for about three seconds, and try turning the power on again.</li> </ul>
Picture quality is strange	<ul style="list-style-type: none"> <li>• Press the MENU switch, select <b>Quality</b>, and check that there are no problems with setting values.</li> </ul>

## **The following items do not indicate a problem with or damage to the unit.**

Conditions such as described below may arise due to the nature of liquid crystals.

- **The response time, brightness, or color of liquid crystals may vary depending on the ambient temperature.**
- **Irregular brightness, flicker, vertical lines, or minute spots may appear depending on the image being displayed.**
- **Flicker may be more pronounced when the liquid crystal display frequency is 50Hz, 48Hz, or 47.95Hz, as compared to a frequency of 60Hz or 59.94Hz.**
- **Optical characteristics (brightness, display irregularities, etc.) vary depending on the operating time. These characteristics particularly vary at low temperatures.**
- **Displayed colors may change depending on the viewing angle.**
- **Noise may occur on the startup screen.**
- **Ghosting may occur. Avoid the display of a fixed pattern for an extended period of time.**
- **Horizontal lines may appear when an aspect ratio of 16:9 is used with 1080i input.**

## **If an Error or Problem Occurs**

- **If an error or problem does occur for some reason, please contact the retail outlet where you purchased the product or our sales office.**
- **For problems with the LCD panel, we will repair or replace it for a fee, regardless of whether it is inside the warranty period.**

## Notes

We will replace any manuals with missing pages or pages out of order.

This product is copyrighted by Astro Design Corporation.

Unauthorized use or duplication of this manual, in whole or in part, is prohibited.

The contents of this manual are subject to change without prior notice for the purpose of making improvements.

Note that we cannot take responsibility for adverse affects resulting from the misuse of this product.

For questions about this product, please contact the retail outlet where you purchased it or use the contact information given below.

Products and product names mentioned in this manual are the trademarks or registered trademarks of the respective company.