



HD/SD 6-inch LCD Waveform Monitor

WM-3014

Instruction Manual

Ver.1.00



HD/SD 6-inch LCD Waveform Monitor

WM-3014

Instruction Manual

2006.8

Ver.1.00

ASTRODESIGN,Inc

CONTENTS

CONTENTS.....	i
INTRODUCTION.....	iv
SAFETY PRECAUTIONS.....	iv
Concerning the monitor.....	iv
Concerning the power cord.....	iv
Concerning foreign matter.....	v
Concerning the power supply.....	v
Concerning the liquid crystal.....	v
Concerning impact.....	vi
Concerning the installation and operation locations.....	vi
Concerning problems due to the nature of liquid crystal.....	vii
Chapter 1 CONCERNING THE WM-3014.....	1
Outline of WM-3014.....	1
Chapter 2 PARTS AND THEIR FUNCTIONS.....	3
2.1 WM-3014 front panel view and parts.....	3
2.2 WM-3014 rear panel view and parts.....	6
Chapter 3 OPERATION.....	9
3.1 Connection procedure.....	9
3.2 Usage.....	9
3.3 Concerning the screens.....	10
3.4 Operation.....	16
3.4.1 PICTURE1 mode.....	17
3.4.1.1 Function screen.....	17
3.4.1.2 Brightness setting screen.....	18
3.4.1.3 Contrast setting screen.....	19
3.4.1.4 Chroma setting screen.....	20
3.4.1.5 Gamma setting screen.....	22
3.4.1.6 Other image setting screen.....	23
3.4.1.7 Color setting screen.....	25
3.4.2 PICTUER2 mode.....	26
3.4.2.1 Normal screen.....	26
3.4.2.2 User marker setting screen.....	28
3.4.2.3 Color setting screen.....	29
3.4.3 PICTURE3 mode.....	30
3.4.3.1 Regular screen.....	30
3.4.3.2 Color setting screen.....	31
3.4.4 WAVEFORM mode.....	32
3.4.4.1 Function screen.....	32
3.4.4.2 DISPLAY setting screen.....	33
3.4.4.3 SWEEP setting screen.....	34
3.4.4.4 GAIN/MAG setting screen.....	36

3.4.4.5	CURSOR setting screen	38
3.4.4.6	SETTING mode setting screen	39
3.4.4.7	Color setting screen	41
3.4.5	VECTOR mode	42
3.4.5.1	Regular screen	42
3.4.5.2	VECTOR mode setting screen	44
3.4.5.3	Color setting screen	45
3.4.6	STATUS mode	46
3.4.6.1	Regular screen	46
3.4.6.2	Color setting screen	47
3.4.7	AUDIO mode	48
3.4.7.1	Audio level meter screen	48
3.4.7.2	Audio vector screen	49
3.4.7.3	Color setting screen	50
3.4.8	Multi mode	52
3.4.8.1	Multi mode 1 screen	52
3.4.8.2	Multi mode 2 screen	54
3.4.9	PRESET mode	55
3.4.10	MENU mode	56
3.4.10.1	Regular screen	56
3.4.10.2	Color setting screen	58
3.4.11	Compare mode	59
3.4.11.1	Outline	59
3.4.11.2	Compare mode 1	60
3.4.11.3	Compare mode 2	61
3.4.11.4	Compare mode 3	63
3.4.11.5	Compare mode 4	64
Chapter 4	MAIN SPECIFICATIONS	65
4.1	Input formats	65
4.2	Input signal systems	66
4.3	Display system	66
4.4	Headphones output format	67
4.5	Concerning the adjustment values	68
4.6	Concerning the 4:3 function	71
4.7	Concerning the audio level meter	73
4.8	Settings at initialization	74
Common setting items	74	
Setting items by channel	75	
4.9	General specifications	77
4.10	Outline drawings	78
Chapter 5	STANDARD AND OPTIONAL ACCESSORIES	79
5.1	Standard accessories	79

Chapter 6 MAINTENANCE AND OTHER PROCEDURES.....	81
When the monitor does not operate properly.....	81
When trouble or malfunctioning occurs.....	81

INTRODUCTION

Thank you very much for purchasing this model WM-3014 HD LCD waveform monitor.

This manual contains the procedures to be followed to operate the WM-3014, the checkpoints and precautions to be observed, and so on.

Improper handling may result in malfunctioning. Before using the WM-3014, please read through these instructions to ensure that you will operate the monitor correctly.

After reading through the manual, keep it in a safe place for future reference.

SAFETY PRECAUTIONS

WARNING

Concerning the monitor

- Do not subject the monitor to strong impact or throw it around. Doing so may cause the liquid crystal to leak and/or the monitor to malfunction, rupture, generate heat and/or cause a fire.
- Do not use the monitor wherever there is a risk of ignition or explosions.
- Do not place the monitor inside a microwave oven or other heating or cooking appliance or pressure vessel. Doing so may cause heat or smoke to be generated in the monitor, combustion and/or damage to the circuit components.
- Inside the monitor are some high-voltage parts: since exposure to these parts may result in electric shocks or burns and/or malfunctioning, refrain from disassembling, repairing or remodeling the monitor.
- If a thunderstorm should occur while the monitor is being used outdoors, immediately turn off its power, disconnect the power cable from the main unit, and move the monitor to a safe place.

Concerning the power cord

- Always take hold of the molded part of the plug when disconnecting the power cord.
- Do not use force to bend the power cord or bunch it up for use. This may cause a fire.
- Do not place heavy objects on top of the power cord. This may damage the cord, causing a fire or electrical shock.

Concerning foreign matter

- **Do not spill liquids inside the monitor or drop inflammable objects or metal parts into it. Operating the monitor under these conditions may cause a fire, electric shocks and/or malfunctioning.**

CAUTION

Concerning the power supply

- **Use a supply voltage within the range of DC 10V to 18V \pm 5% for the monitor.**
- **In order to avoid malfunctioning and trouble, it is recommended that the accessory AC/DC adapter be used. In the event that another power supply is to be used, ensure that its supply voltage and polarity are compatible with the monitor.**
- **Do not turn the power back on immediately after having turned it off. Doing so can cause malfunctioning.**
- **Bear in mind that if the same DC power supply as microphones, amplifiers, speakers and other audio products should be used for the monitor, the sound may be adversely affected.**

Concerning the liquid crystal

- **Due to the nature of liquid crystal, some picture elements may be missing (bright spots, flashing spots, etc.) at times.**
- **Do not touch any liquid crystal which has leaked from the liquid crystal panel.**

If the liquid crystal panel has been inadvertently damaged and the liquid (liquid crystal) inside has leaked out, keep the liquid away from your mouth and skin and do not inhale its vapors.

- **In the event that liquid crystal has made contact with your eyes or mouth, rinse it off with water immediately. If it has come into contact with your skin or clothing, wipe it off immediately with alcohol, and then wash it off with soap. Leaving it in place may damage your skin or clothing.**
 - **Exercise care with the glass of a broken liquid crystal panel.**
- If the panel has broken, take care not to cut your hands on the glass shards. If you should touch an area where the glass has broken off, you may injure yourself.
- **The LCD panel is a high-precision component and, as such, the following care must be taken in its handling.**

- Wiping the panel's surface with benzene, paint thinners, etc. will cause a deterioration in its quality.
- If water (salty water) is left on the display surface, discoloration and staining will result.
- Exposing the panel directly to ultraviolet rays for an extended period may cause the deflection panel to turn brown, in turn causing the contrast to drop and other forms of deterioration to develop in the display quality.
- Moisture inside the monitor due to condensation, etc. may cause unevenness in the colors.
- Directly tapping the surface or bumping it into objects may crack the panel, etc.
- Do not attempt to disassemble the panel since leaking liquid crystal may make contact with your skin, which is hazardous.

■ Handle the liquid crystal protective panel carefully.

Carefully wipe off any fingerprints or dirt on the liquid crystal protective panel with a cleaning agent used to clean office automation equipment, for example. Rubbing the panel with too much force may mark or damage the panel.

Concerning impact

- This is a precision instrument and, as such, subjecting it to impact may cause malfunctioning. Take special care when moving the monitor.
- Do not drop the monitor.

Concerning the installation and operation locations

■ Installing the monitor in the following kinds of locations may cause malfunctioning and/or accidents.

- Locations with an ambient temperature outside the range of 0 to 40 degrees Celsius (see Note 1)
- Locations with an ambient humidity outside the range of 30 to 80% RH
- Locations in the vicinity of an air conditioner or subject to rapid temperature changes or to the formation of condensation
- Locations exposed to direct sunlight (see Note 2)
- Locations exposed to corrosive gases or high concentrations of dust
- Locations where strong magnetic fields are generated
- Locations where the monitor may be splashed with water, oil, chemicals, etc.
- Locations to which vibrations are transmitted from the floor
- Unstable locations

■ Take care to meet the following conditions in order to ensure that the monitor will be used properly.

- Do not place heavy objects such as another monitor on top of the monitor.
- Avoid placing any objects around the monitor.

Note 1: When the surface temperature of the LCD panel exceeds 60 degrees Celsius, the panel's backlight and other parts may be damaged.

Note 2: Exposing the panel directly to ultraviolet rays for an extended period may cause the deflection panel to turn brown, in turn causing the contrast to drop and other forms of deterioration to develop in the display quality.

Concerning problems due to the nature of liquid crystal

The following minor problems may occur due to the nature of liquid crystal.

- **The liquid crystal's response time, brightness and colors may vary depending on the ambient temperature.**
- **Depending on what is displayed, unevenness in the brightness, flicker, vertical stripes and/or very small flecks may appear.**
- **The optical characteristics of liquid crystal (such as unevenness in the brightness or display) change in accordance with the operating time. These changes are particularly apparent at low temperatures.**
- **The display colors may change depending on the view angle.**
- **Noise may appear on the startup screen.**
- **Image lag may occur. Avoid displaying the same pattern for a prolonged period of time.**

1

CONCERNING THE WM-3014

The WM-3014 is a compact, lightweight and portable LCD waveform monitor which comes in handy for monitoring the pictures being shot during live broadcasts, on location or in studios.

The camera battery is supported as the power supply so that pictures, waveforms and sound can now be monitored even in locations where it would be difficult to carry in equipment.

A full range of functions is provided including functions for adjusting the brightness, contrast and chroma levels as well as functions for displaying markers.

Input signals in a total of 23 HDTV and two SDTV video formats as well as NTSC and PAL composite input signals are supported. In regard to the PAL signals, however, the waveforms of the 3 lines each at the start and end of the video signals will be more disturbed than in actuality.

Outline of WM-3014

■ 6.3-inch a-Si TFT LCD panel featured

■ HD-SDI, SD-SDI or YPbPr HD analog signals supported as the input

■ 25 different video formats supported

Standards complied with by HD-SDI signals: SMPTE 292M, BTA S-004B standards
(1.485 Gbps SDI input)

Standards complied with by SD-SDI signals: SMPTE 259M standard (270 Mbps SDI input)

Standards complied with by analog input and supported formats:
SMPTE 274M, SMPTE 296M, BTA S-001B standards

Composite input (NTSC: SMPTE 170M, PAL: ITU-R.BT624-4 complied with in part)

■ SDI IN (x2), SDI MONITOR OUT, HD analog input (ANALOG Y, ANALOG Pb, ANALOG Pr) and composite input (NTSC, PAL) connectors provided

* When composite signals are input, the waveforms displayed are the waveforms which appear after the component signal conversion. In regard to the PAL signals, however, the waveforms of the 3 lines each at the start and end of the video signals will be more disturbed than in actuality.

■ Image adjustment functions

Brightness adjustment function (brightness can be adjusted separately for G, B and R) $\pm 50\%$

Contrast adjustment function (contrast can be adjusted separately for G, B and R) 0 to 200%

Chroma level adjustment function 0 to 200%

Chroma boosting function

Separate ON/OFF functions for G, B and R

Peak function

Chroma signal OFF function

Gamma adjustment function (gamma can be adjusted separately for G, B and R)

■ Marker displays

Center marker, frame marker, safety markers (95%, 93%, 88%, 80%)

Markers for down-conversion (4:3, 13:9, 14:9)



Markers for cinema formats (2.35:1 Cinemascope, 1.85:1 Cinema Vista, 1.66:1 Euro Vista)

User variable markers

- **Single-action operation for selecting input channels, partial display/non-display of information, picture overlay and freeze/update using the switches on the front panel**
- **Many different display modes available**
Picture, waveform, vector, audio level meter, audio vector mode, multi display and picture waveform simultaneous display modes
- **Compare mode provided**
Frozen images and the current images can be displayed for the purposes of comparison.
- **Lighting of red, green LEDs at top of screen using external control (contact supply type)**
- **Loading of preset data enabled by external control (contact supply type)**
- **Preset switches provided on front panel (for loading and saving the preset data)**
- **Automatic tracking of input signals supported**
- **Automatic 1/1.000 and 1/1.001 frame rate tracking and input signal detection functions**
- **Reference input (HD analog tri-level sync, BB_525, BB_625)**
- **CRC error detection function (during HD-SDI input) for input channels**
- **Time code (VITC) display (during HD-SDI input)**
- **Functions for locking the panel switches and storing the settings**
- **Light weight and slim-line dimensions**
- **DC 12V supported (10-18V)**
- **Camera battery supported**

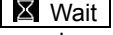
Table 2.1 Front panel parts

No.	Part	Description of function
1	POWER switch / LED	This switch is used to turn the power ON and OFF. (Its LED lights up green while the power is supplied.)
2	LOCK switch / LED	This switch is used to lock the panel switches and save the settings simultaneously.  Wait appears at the bottom right of the screen while the settings are being saved. The settings which have been saved are loaded when the power is turned on. (*1) (The LED of this switch lights up yellow while the panel switches are locked.)
3	Mode switch	This switch is used to select the monitor's mode.
		PICTURE1 Mainly for performing the image adjustments on the picture screen.
		PICTURE2 Mainly for selecting the auxiliary functions on the picture screen.
		PICTURE3 For showing the screen on which the settings items are not displayed.
		WAVEFORM For displaying the waveforms.
		VECTOR For displaying the vectorscope.
		STATUS For displaying the input data as numerical values.
		AUDIO For displaying the embedded audio level meter or audio vectors.
		MULTI For the multi display.
		PRESET For establishing the read mode for the user settings stored inside the monitor.
MENU For selecting the input signals, etc.		
4	Adjustment dial	This dial is used to adjust and select the settings.
5	Set switch	For entering or canceling the settings.
6	Headphones jack	The sound is output from this jack (diameter: 35 mm). (*2)
7	Liquid crystal display	The images appear on this display.
8	TALLY 1	Tally lamp (red): This is controlled by the rear panel tally connector (contact supply type).
9	TALLY 2	Tally lamp (green): This is controlled by the rear panel tally connector (contact supply type).
10	1/4-20UNC threaded hole	Threaded hole for the screw to secure the monitor (used to secure the monitor to a tripod, arm, etc.).
11	INPUT switch	This switch is used to select SDI A, SDI B, analog component or analog composite for the input signals. The input signals are selected in the following sequence: SDI A ⇒ SDI B ⇒ analog component ⇒ analog composite ⇒ SDI A (back to the first selection).
12	DISPLAY switch Half Turn switch	This switch is used to set whether the setting items of function indicators F1 to F5 are to be displayed on the screen or not. When it is held down (for more than one second), the top and bottom of the screen are inverted.
13	OVERLAY switch Color switch	This switch is used to change the picture overlay settings. When it is held down (for more than 1 second), the color setting screen appears. (The color setting items differ according to the mode selected.)
14	FREEZE switch	This switch is used to select freeze or update.
15	FUNC switch	This switch is used to switch the setting items.
16	F1 switch	The function of this switch differs depending on the mode selected. It works for the display that has appeared most recently.
17	F2 switch	The function of this switch differs depending on the mode selected. It works for the display that has appeared most recently.
18	F3 switch	The function of this switch differs depending on the mode selected. It works for the display that has appeared most recently.
19	F4 switch	The function of this switch differs depending on the mode selected. It works for the display that has appeared most recently.
20	F5 switch	The function of this switch differs depending on the mode selected. It works for the display that has appeared most recently.

21	P1 switch	<p>Operations in modes other than the freeze mode</p> <p>These are the preset switches. They are used to save data in, and load data from, the memory space with the number corresponding to the current setting. When a switch is held down, the current setting is saved in the switch.  Wait appears at the bottom right of the screen while the data is being saved. <u>If the power is turned off while  Wait is displayed, the data saved inside the monitor may be initialized.</u></p> <p>If one of these switches is pressed while the PRESET mode is selected, the data saved in the memory will be loaded. If the mode has not been saved, only the picture will be displayed.</p> <p>Operations in the freeze mode</p> <p>These switches select compare modes 1 to 4 and serve as the EXIT button. (For further details, refer to “3.4.11 Compare mode.”)</p>
22	P2 switch	
23	P3 switch	
24	P4 switch	
25	P5 switch	

*1: Do not turn off the power while the settings are being saved. If the LOCK switch is released or the power is turned off while settings are being saved, the initial values may be set instead of the saved settings when the power is next turned on.

*2: Audio signals are output when 48 kHz embedded sound has been multiplexed in the SDI signals.

2.2 WM-3014 rear panel view and parts

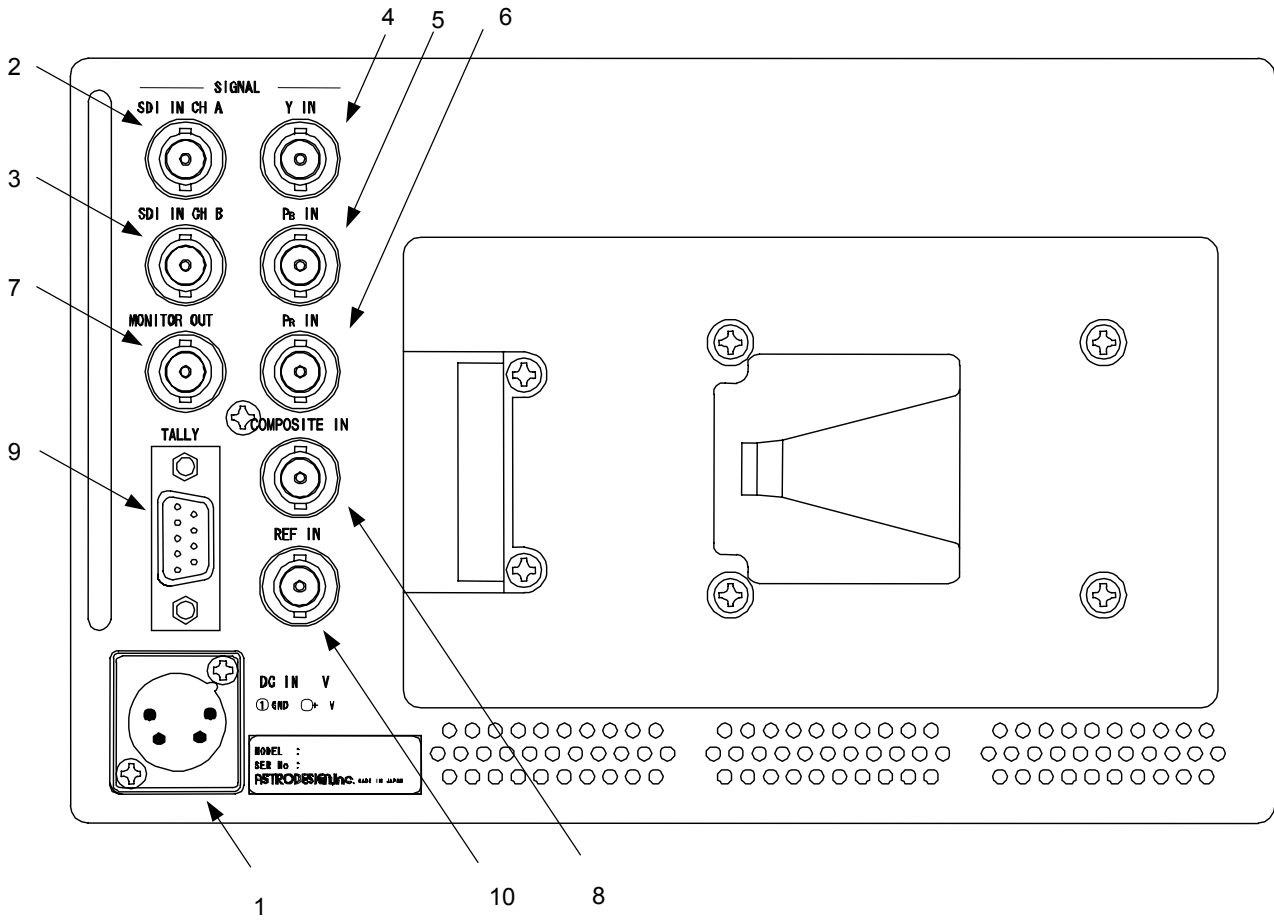
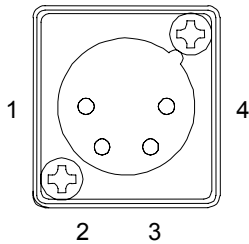

Fig. 2.2 WM-3014 rear panel view

Table 2.2 Names of rear panel parts

No.	Part	Description of function
1	Power socket (*1)	Cannon connector, DC power input socket (GND: pin 1; DC IN: pin 4).
2	SDI IN Ach	HD-SDI signal input connector.
3	SDI IN Bch	HD-SDI signal input connector.
4	Y IN	HD analog Y signal input connector Synchronization is provided using the Y signal in the case of analog inputs.
5	Pb IN	HD analog Pb (Cb) signal input connector
6	Pr IN	HD analog Pr (Cr) signal input connector
7	MONITOR OUT	Output connector for simplified monitoring of SDI input signals. SDI A images are output when the SDI A input is selected. SDI B images are output when the SDI B input is selected. SDI A images are output when the analog input or composite input is selected.
8	COMPOSITE IN	Composite signal input connector When composite signals are input, the waveforms, etc. displayed are the waveforms, etc. obtained after the signals have been converted into component signals. In regard to PAL signals, however, the waveforms of the 3 lines each at the start and end of the video signals will be more disturbed than in actuality.
9	TALLY connector (*2)	D-sub 9pin (female)
10	REF IN	Reference input connector (HD tri-level sync, BB_525, BB_625), terminated with a 75Ω resistance.

*1: Power socket (no.1 in rear panel view)



Pin No.	Function
1	GND
2	NC
3	NC
4	DC IN (10-18V)

*2: TALLY connector (no.9 in rear panel view)

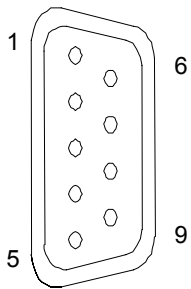

Pin No.	Function
1	GND
2	TALLY 2(G)
3	PRESET 1
4	PRESET 2
5	GND
6	PRESET 3
7	TALLY 1(R)
8	PRESET 4
9	PRESET 5

When GND and pin 2 are shorted, the green tally lamp lights; when GND and pin 7 are shorted, the red tally lamp lights.

Details on the PRESET pins are provided below. Any of these pins become operational when they are shorted with GND.

Their functions are established by setting the pins from high to low (MAKE) (edge operation). (The switch pressed last has priority.)

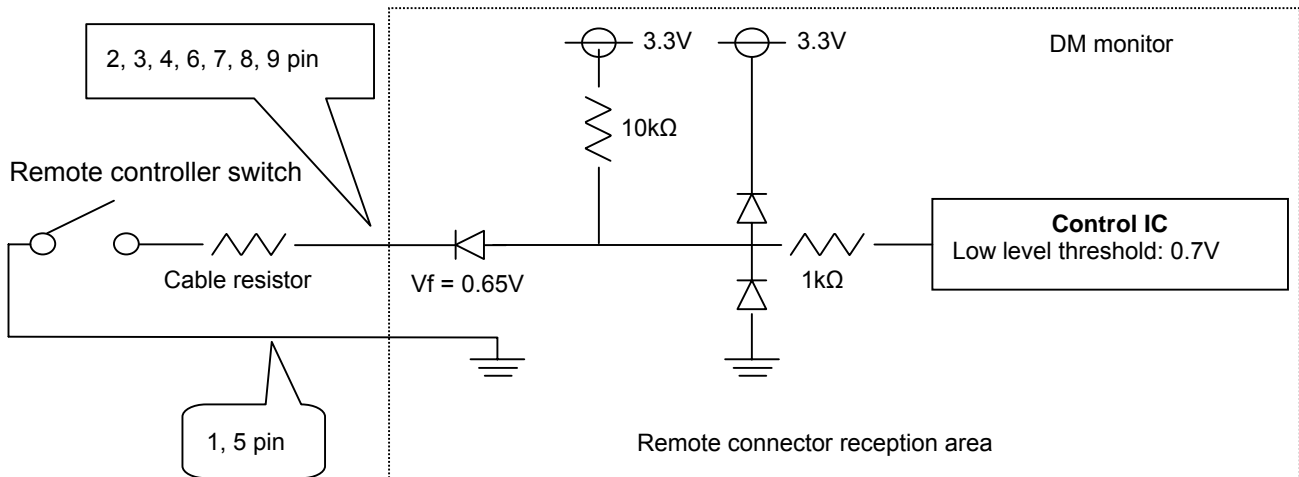
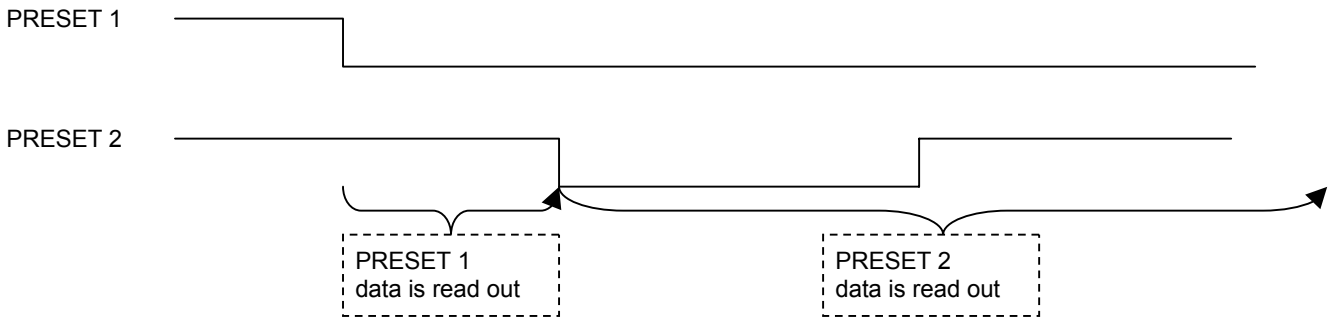

* Design the circuitry in such a way that the cable resistance is 50Ω or less.

CAUTION Do not plug a cable into or unplug one from the TALLY connector while the power is supplied to the monitor.

3

OPERATION

3.1 Connection procedure

This section describes how to connect the following to the WM-3014.

(1) Connecting the power supply

Check that the monitor's POWER switch is at the OFF position, and connect the Cannon connector of the AC/DC adapter to the WM-3014's power socket (no.1 on the rear panel view). Check the shapes of the connector and socket before proceeding with the connections.

(2) Connecting the input signals

When SDI signals are to be input

When SDI signals are to be input, use BNC coaxial cables to make the connections to the SDI IN connectors.

The SDI IN connectors are where the SDI signals are input; MONITOR OUT is the output connector which is used for the simplified monitoring of the SDI input signals.

Supply serial signals complying with the BTA S-004B standard as the HD-SDI input signals.

Use a coaxial cable (5C-FB or its equivalent) which can handle the 1.5 GHz band.

Supply serial signals complying with the SMPTE259M (270Mbit/s) standard as the SD-SDI input signals.

(3) Connecting the remote controller

Check that the monitor's POWER switch is at the OFF position, and connect the remote controller to the WM-3014's TALLY connector (no.9 on the rear panel view).

Check the shapes of the connector and socket before proceeding with the connections.

3.2 Usage

A protective film is adhered to the surface of the LCD panel. Peel it off before using the WM-3014. After checking the connections, turn on the power using the POWER switch on the front panel of the WM-3014. The POWER LED lights, and images are displayed. If the POWER LED fails to light, check the connections again.









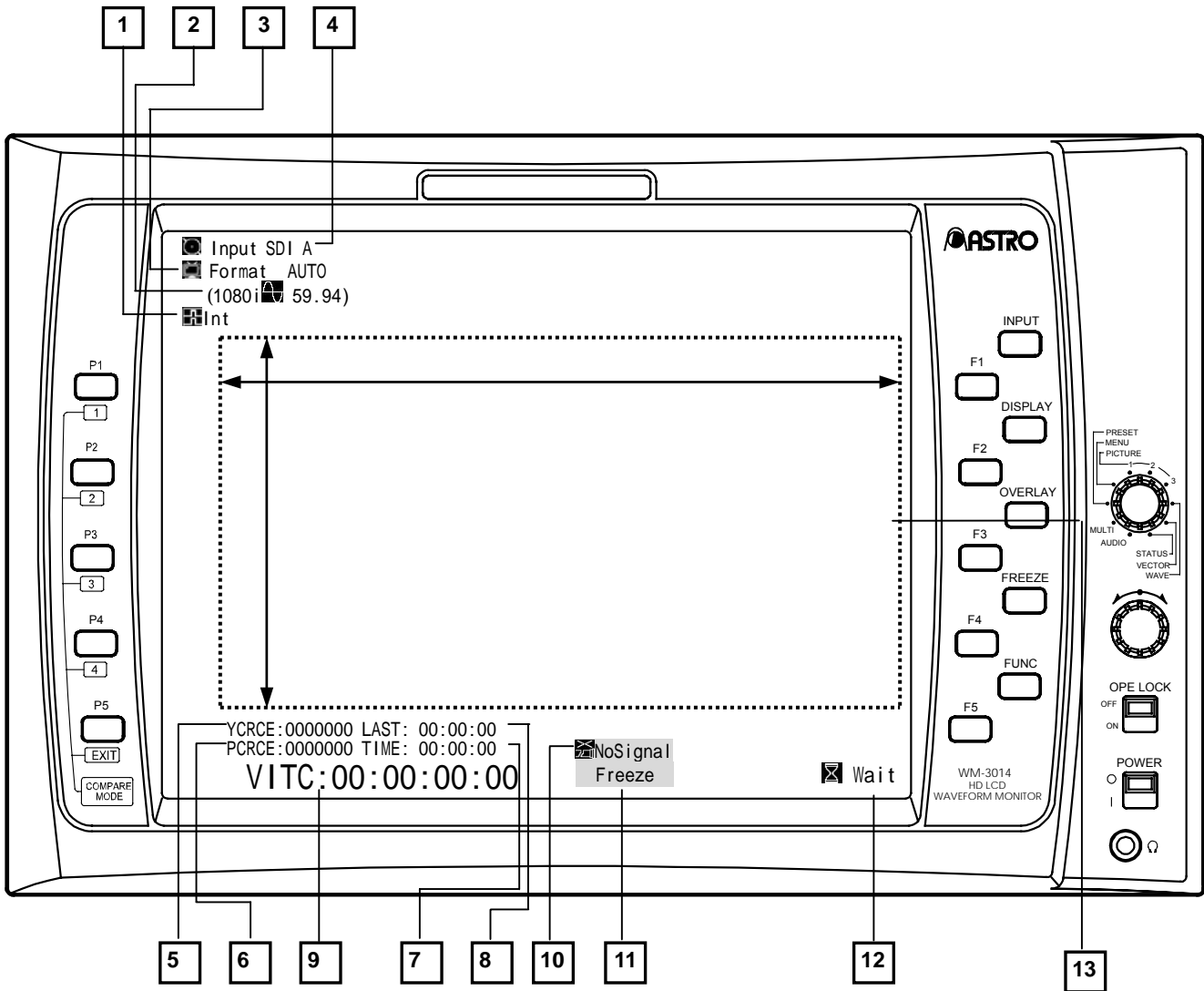



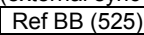
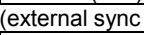



To conduct the simplified monitoring of the SDI input signals, use the MONITOR OUT connector. If no input signals are supplied, the image area appears all black, and  NoSignal is displayed in red on the screen.

3.3 Concerning the screens

This section describes the screen displays of the WM-3014 and the setting procedures.

Regular screen

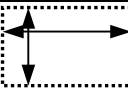

No.	Item	Description	Display modes
1	 (Reference)	The input reference signal is displayed here.  denotes "Internal" (internal sync signal).  denotes "Reference" (external sync signal: HD tri-level signals).  denotes "Reference" (external sync signal: NTSC black burst signal).  denotes "Reference" (external sync signal: PAL black burst signal).	P1, P2, W, V, ST, A, ML, MN
2	 (frequency)	The frequency of the input signals is displayed here. If no signals are input (when  NoSignal appears on the screen), "" is displayed.	P1, P2, W, V, ST, A, ML, MN
3	 Format	The selected format is displayed here. Indicated within the parentheses on the line below are the input signal format and field (or frame) frequency. When analog input has been selected even if 1035i input signals are supplied, these signals will be identified as 1080i signals. If no signals are input (when  NoSignal appears on the screen), "" is displayed. If no signals are input or if the format which has been set differs from the format of the actual input signals,  appears in red.	P1, P2, W, V, ST, A, ML, MN
4	 Input	Displayed here is the input channel (SDI A, SDI B, Analog or VBS) which has been selected by the INPUT switch.	P1, P2, W, V, ST, A, ML, MN
5	YCRCE	This is where the Y signal is checked for CRC errors and the number of errors is displayed. When an error is found, YCRCE appears in red for one second. Note: The CRC errors are not counted when SD-SDI signals or analog signals are input. Neither are they counted for one second after the input signals have been changed by the INPUT switch.	P1, P2, W, V, ST, A, ML, MN
6	PCRCE	This is where the Pb and Pr signals are checked for CRC errors and the number of errors is displayed. When an error is found, PCRCE appears in red for one second. Note: The CRC errors are not counted when SD-SDI signals or analog signals are input. Neither are they counted for one second after the input signals have been changed by the INPUT switch.	P1, P2, W, V, ST, A, ML, MN
7	LAST	The time elapsed since the last error was found is displayed here.	P1, P2, W, V, ST, A, ML, MN
8	TIME	The time elapsed after the WM-3014 was started up or after the error count was reset is displayed here.	P1, P2, W, V, ST, A, ML, MN
9	VITC	The time code (VITC) is displayed here. It is displayed only when SDI signals are selected. Note: It is displayed accurately when HD-SDI signals are selected, but it may not be displayed accurately in the case of SD-SDI signals.	P1, P2, W, V, ST, A, ML, MN
10-a	 NoSignal	 NoSignal appears in red if the input signals are at variance from the set signals.	P1, P2, P3, W, V, ST, A, ML, PRE, MN
10-b	 NoReference	 NoReference appears in red if the reference signal is not input properly (if it is not input or if it is at variance from the setting) when a setting other than  (external sync) has been selected as the reference setting of the WM-3014. If the conditions for  are satisfied also at the same time,  takes precedence.	P1, P2, P3, W, V, ST, A, ML, PRE, MN
11	Freeze	This indicates the freeze status. When the freeze status is established, Freeze appears in blue.	P1, P2, P3, W, V, ST, A, ML, PRE, MN
12	 Wait	This indicates that data is being saved.	P1, P2, P3, W, V, ST, A, ML, PRE, MN
13		The dotted lines in the diagram represent the image area. The screen size is normally 960 × 540 pixels. In the case of the SD format, the size is 720 × 540 pixels.	

Abbreviations used in display mode column:

P1···PICTURE1 mode, P2···PICTURE2 mode, P3···PICTURE3 mode, W···WAVEFORM mode, V···VECTOR mode, ML···MULTI mode, ST···STATUS mode, A···AUDIO mode, PRE···PRESET mode, MN···MENU mode



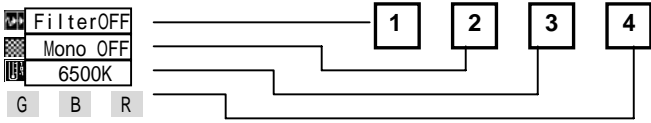























Picture mode



5 BRIGHTNESS	6 CONTRAST	7 CHROMA	8 GAMMA	9 OTHERS
Bright 0.0%	Contrast 100.0%	Pb(Cb) 100.0%	Y-Gamma 2.200	Peaking OFF
G-Bright 0.0%	G-Cont 100.0%	Pr(Cr) 100.0%	G-Gamma 2.200	
B-Bright 0.0%	B-Cont 100.0%		B-Gamma 2.200	
R-Bright 0.0%	R-Cont 100.0%		R-Gamma 2.200	

FRM	CTR	USER	
95%	93%	88%	80%
4:3	13:9	14:9	
2.35:1	1.85:1	1.66:1	10

Marker H	50%	
Marker V	50%	11

No.	Item	Description	Display modes
1	 Filter	This indicates whether the filter is ON or OFF.	P1, P2
2	 Mono	This indicates whether monochrome is ON or OFF.	P1, P2
3	 6500K /  9300K	This indicates the color temperature of the liquid crystal which has been set.	P1, P2
4	  	These indicate the ON or OFF status each for G, B and R. A highlighted display denotes the ON status.	P1, P2
5	 Bright	This indicates the brightness setting.	P1
	 G-Bright	This indicates the G-brightness setting.	
	 B-Bright	This indicates the B-brightness setting.	
	 R-Bright	This indicates the R-brightness setting.	
6	 Contrast	This indicates the contrast setting.	P1
	 G-Cont	This indicates the G-contrast setting.	
	 B-Cont	This indicates the B-contrast setting.	
	 R-Cont	This indicates the R-contrast setting.	
7	 Pb (Cb)	This indicates the Pb (Cb) setting.	P1
	 Pr (Cr)	This indicates the Pr (Cr) setting.	
	 ChromaUp	This multiplies the chroma signal by 3.	
8	 Y-Gamma	This indicates the Y-gamma setting.	P1
	 G-Gamma	This indicates the G-gamma setting.	
	 B-Gamma	This indicates the B-gamma setting.	
	 R-Gamma	This indicates the R-gamma setting.	
9	 Peaking	This indicates the peaking setting.	P1
10	 (Marker)	Displayed here is a list of the usable markers. The currently selected marker is highlighted. <Types of markers> FRAME, CENTER, USER, 95%, 93%, 88%, 80%, 4:3, 13:9, 14:9, 2.35:1, 1.85:1, 1.66:1 Note: When SD-SDI signals are input, the 4:3, 13:9 and 14:9 markers will not be displayed even when one of these marker designations is highlighted. Furthermore, if there are no input signals and  has been selected for the format, the 1080 marker is displayed.	P1, P2
	 Marker H	This indicates the horizontal setting of the user marker.	
	 Marker V	This indicates the vertical setting of the user marker.	P2

Abbreviations used in display mode column:

P1···PICTURE1 mode, P2···PICTURE2 mode, P3···PICTURE3 mode, W···WAVEFORM mode, V···VECTOR mode, ML···MULTI mode, ST···STATUS mode, A···AUDIO mode, PRE···PRESET mode, MN···MENU mode

Other modes

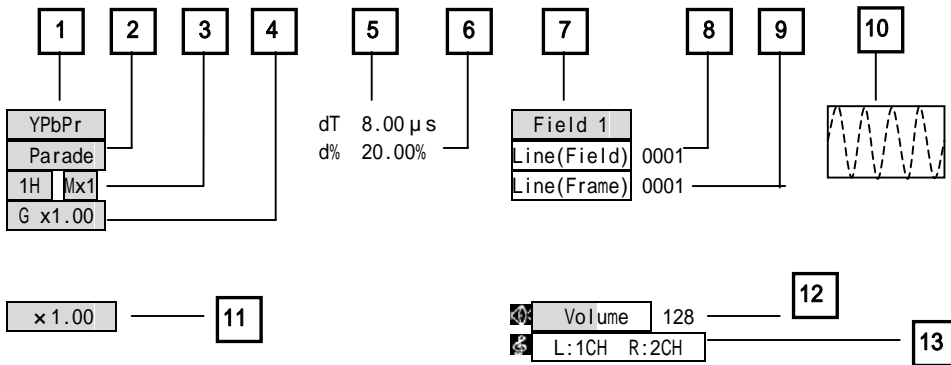

No.	Item	Description	Display modes
1	YPbPr / GBR	This indicates the waveform display method.	W
2	Parade / Overlay	This indicates the parade display or overlay display for the waveforms.	W
3	1H / 2H / 1F / 2F	This indicates the sweep 1H/2H/1F/2F switching.	W
	Mx1 / Mx2 / Mx4	This indicates the magnification ratio.	
4	G x***	This indicates the gain magnification rate.	W
5	dT	This indicates the H cursor difference. It appears when the H cursor is set to ON.	W
6	d% / dV	This indicates the V cursor difference. It appears when the V cursor is set to ON.	W
7	Field 1 / Field 2	This indicates the currently displayed field. It appears when LineSelect is set to ON.	W, V
8	Line (Field)	This indicates the line number in the currently selected field. It appears when LineSelect is set to ON.	W, V
9	Line (Frame)	This indicates the line number. It appears when LineSelect is set to ON.	W, V
10		This indicates the position of the displayed waveform.	W
11	x ***	This indicates the gain magnification rate.	V, A
12	Volume	This indicates the level of the volume which is output from the headphone jack.	A
13	L: xCH R: xCH	This indicates the embedded audio channels through which the sound is output from the headphone jack.	A

Abbreviations used in display mode column:

P1...PICTURE1 mode, P2...PICTURE2 mode, P3...PICTURE3 mode, W...WAVEFORM mode, V...VECTOR mode, ML...MULTI mode, ST...STATUS mode, A...AUDIO mode, PRE...PRESET mode, MN...MENU mode

Color adjustment mode

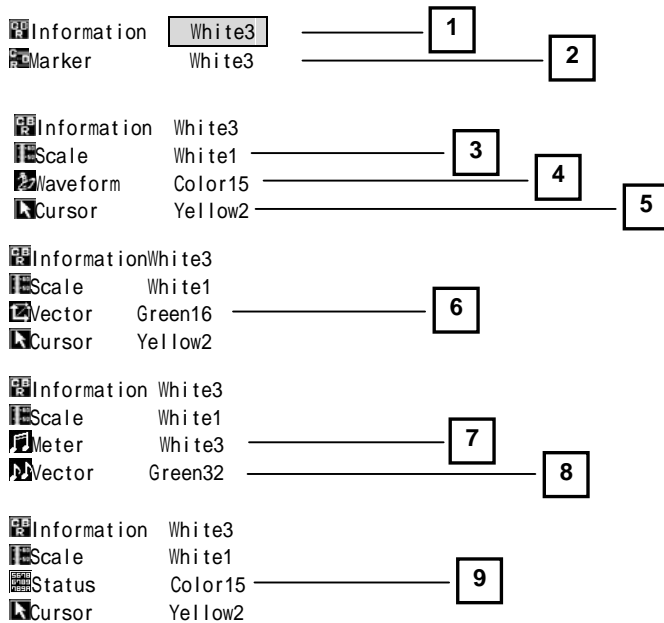

No.	Item	Description	Display modes
1	Information	This indicates the color of the characters.	P1, P2, P3, W, V, ST, A, MN
2	Marker	This indicates the color of the markers.	P1, P2, P3
3	Cursor	This indicates the color of the cursors.	W, V, ST
4	Waveform	This indicates the color and brightness of the waveforms.	W
5	Scale	This indicates the color of the scale.	W, V, ST, A
6	Vector	This indicates the color and brightness of the vectors.	V
7	Meter	This indicates the color of the audio level meter.	A
8	Vector	This indicates the color of the audio vectors.	A
9	Status	This indicates the color of the status.	ST

Abbreviations used in display mode column:

P1··· PICTURE1 mode, P2··· PICTURE2 mode, P3··· PICTURE3 mode, W··· WAVEFORM mode, V··· VECTOR mode, ML··· MULTI mode, ST··· STATUS mode, A··· AUDIO mode, PRE··· PRESET mode, MN··· MENU mode

3.4 Operation

This section describes the WM-3014 screen displays.

Descriptions of each mode are given in the following sections.

PICTURE1 mode (refer to section 3.4.1)

PICTURE2 mode (refer to section 3.4.2)

PICTURE3 mode (refer to section 3.4.3)

WAVEFORM mode (refer to section 3.4.4)

VECTOR mode (refer to section 3.4.5)

STATUS mode (refer to section 3.4.6)



AUDIO mode (refer to section 3.4.7)

MULTI mode (refer to section 3.4.8)

PRESET mode (refer to section 3.4.9)

MENU mode (refer to section 3.4.10)



Do not turn off the power during operations such as when data is being saved (when  Wait appears at the bottom right of the screen). If the power is turned off while  Wait is displayed, the data saved inside the monitor may be initialized.

3.4.1 PICTURE1 mode

3.4.1.1 Function screen

<< Functions >>

The input images are displayed on this screen.

<< Screen >>

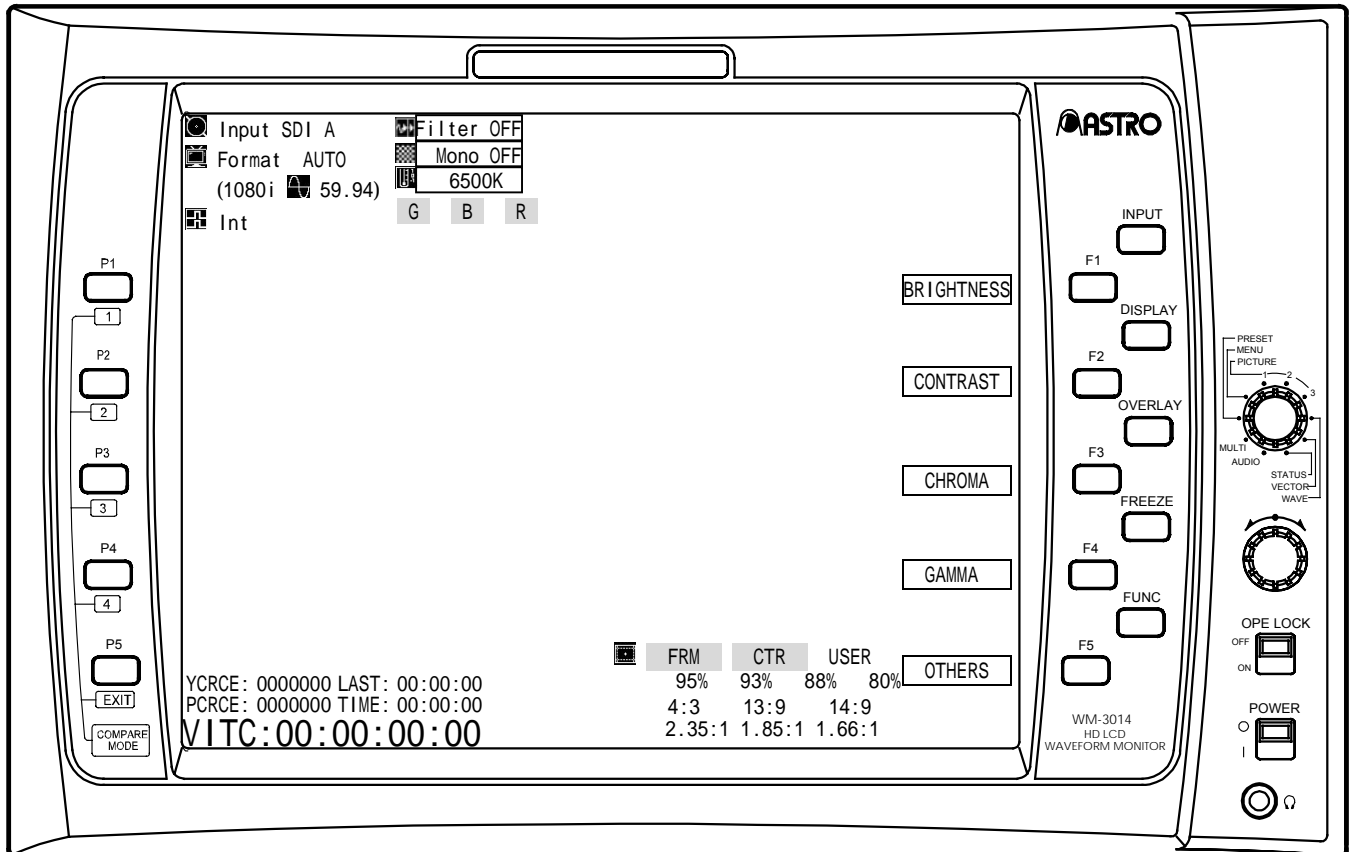

[Description of operations]

Switch	Description of function
FUNC switch	Use this to return to the previous screen.
F1 switch BRIGHTNESS	Use this to display the brightness setting screen. (Refer to section 3.2.1.2.)
F2 switch CONTRAST	Use this to display the contrast setting screen. (Refer to section 3.2.1.3.)
F3 switch CHROMA	Use this to display the chroma setting screen. (Refer to section 3.2.1.4.)
F4 switch GAMMA	Use this to display the gamma setting screen. (Refer to section 3.2.1.5.)
F5 switch OTHERS	Use this to display the screen on which are set the peaking, filter, color temperature, mask and half mask. (Refer to section 3.2.1.6.)

3.4.1.2 Brightness setting screen

<< Functions >>

The input images are displayed, and the following image adjustments are performed on this screen.

- Brightness
- G-Brightness
- B-Brightness
- R-Brightness

<< Screen >>

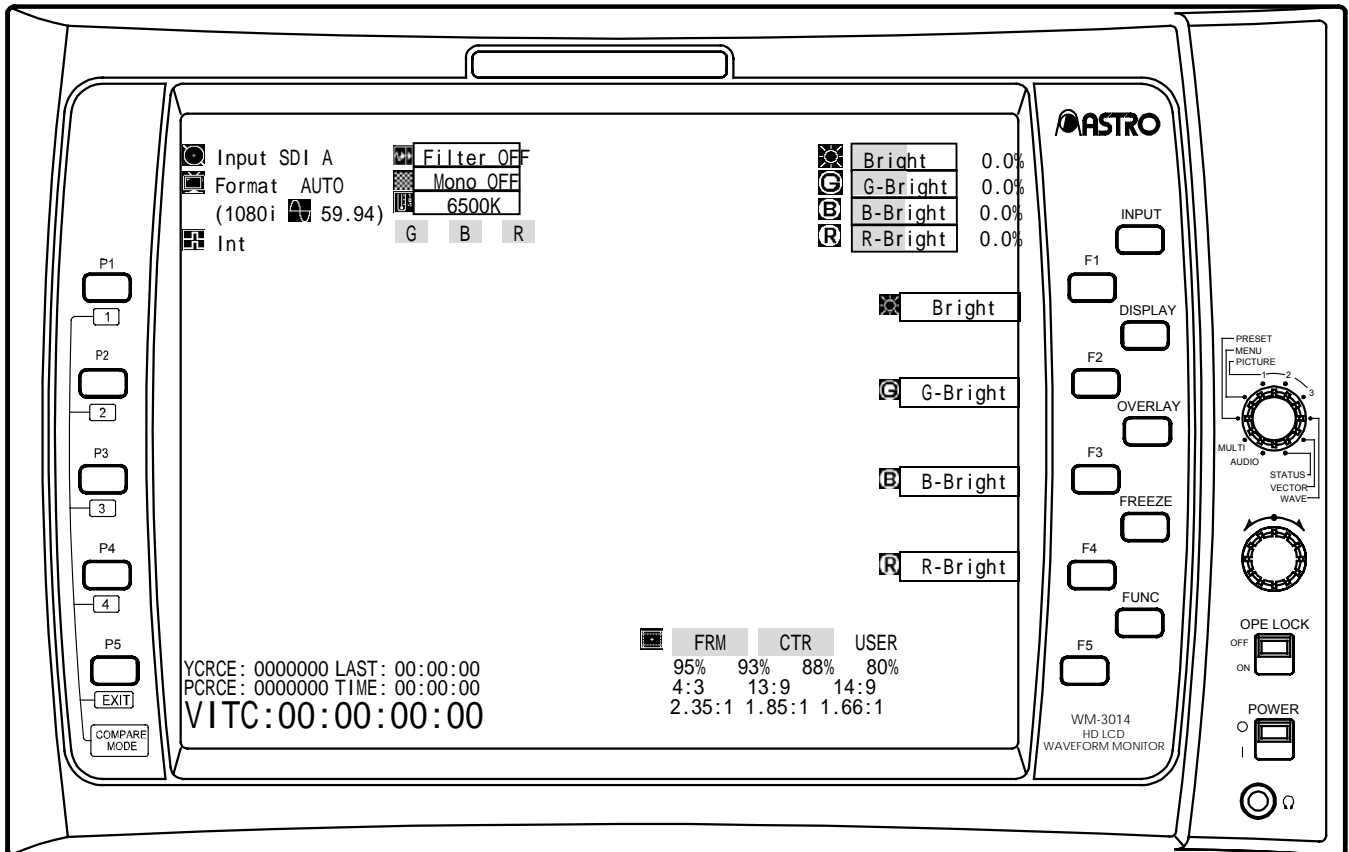

[Description of operations]

Switch	Description of function
FUNC switch	Use this to return to the function screen. (Refer to section 3.4.1.1.)
F1 switch Bright	Use this to adjust the brightness value by turning the adjustment dial. Variable range: -50.00% to +50.00% When the adjustment dial is pressed, the brightness value is returned to the initial value.
F2 switch G-Bright	Use this to adjust the G-brightness value by turning the adjustment dial. Variable range: -50.00% to +50.00% When the adjustment dial is pressed, the G-brightness value is returned to the initial value.
F3 switch B-Bright	Use this to adjust the B-brightness value by turning the adjustment dial. Variable range: -50.00% to +50.00% When the adjustment dial is pressed, the B-brightness value is returned to the initial value.
F4 switch R-Bright	Use this to adjust the R-brightness value by turning the adjustment dial. Variable range: -50.00% to +50.00% When the adjustment dial is pressed, the R-brightness value is returned to the initial value.
F5 switch	No function.

3.4.1.3 Contrast setting screen

<< Functions >>

The input images are displayed, and the following image adjustments are performed on this screen.

- Contrast
- G-Contrast
- B-Contrast
- R-Contrast

<< Screen >>

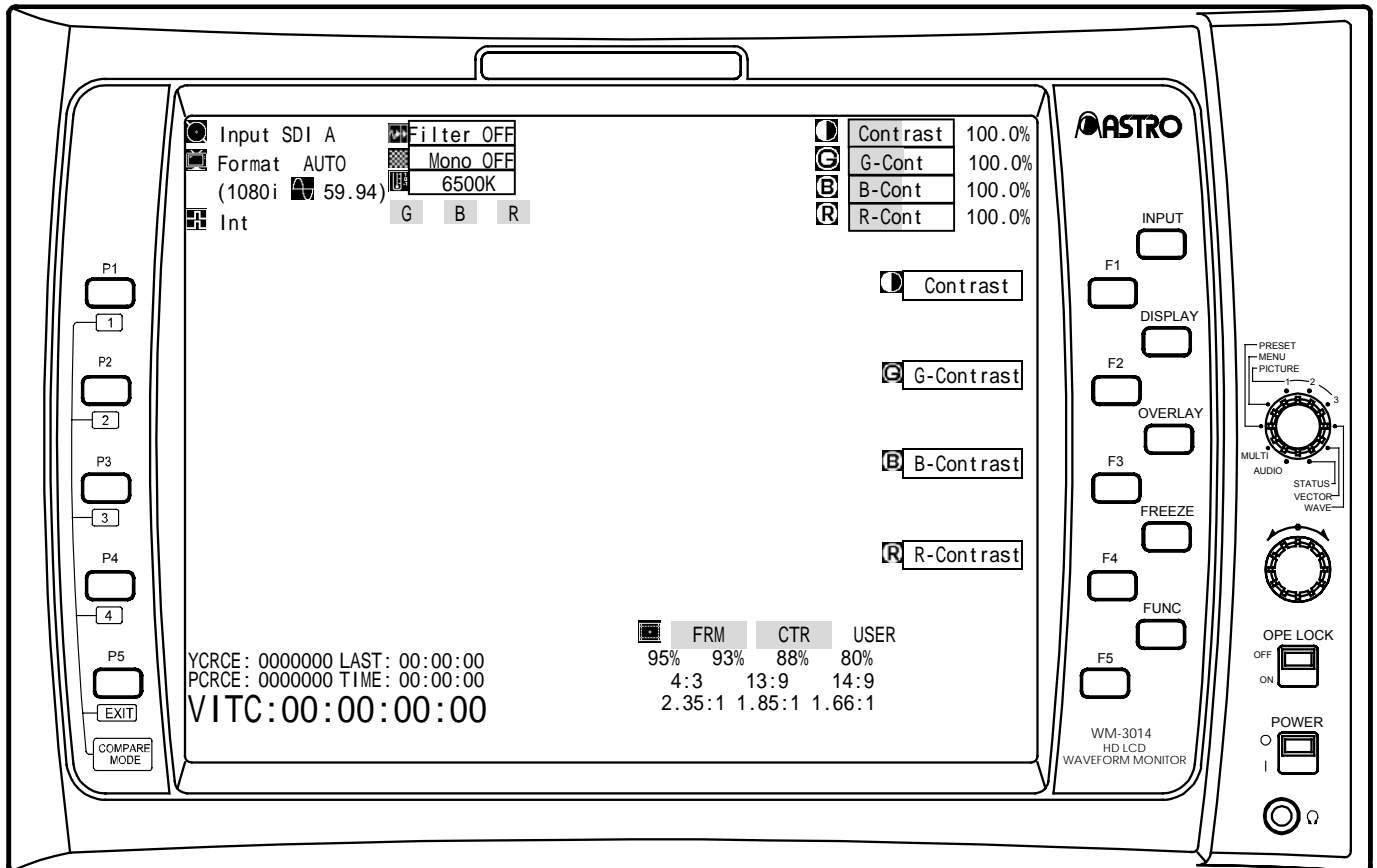

[Description of operations]

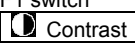
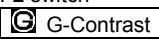
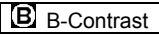
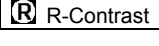
Switch	Description of function
FUNC switch	Use this to return to the function screen. (Refer to section 3.4.1.1.)
F1 switch 	Use this to adjust the contrast value by turning the adjustment dial. Variable range: 0.0% to 200.0% When the adjustment dial is pressed, the contrast value is returned to the initial value.
F2 switch 	Use this to adjust the G-contrast value by turning the adjustment dial. Variable range: 0.0% to 200.0% When the adjustment dial is pressed, the G-contrast value is returned to the initial value.
F3 switch 	Use this to adjust the B-contrast value by turning the adjustment dial. Variable range: 0.0% to 200.0% When the adjustment dial is pressed, the B-contrast value is returned to the initial value.
F4 switch 	Use this to adjust the R-contrast value by turning the adjustment dial. Variable range: 0.0% to 200.0% When the adjustment dial is pressed, the R-contrast value is returned to the initial value.
F5 switch	No function.

3.4.1.4 Chroma setting screen

<< Functions >>

The input images are displayed, and the following image adjustments are performed on this screen.

- Pb (Cb)
- Pr (Cr)

<< Screen >>

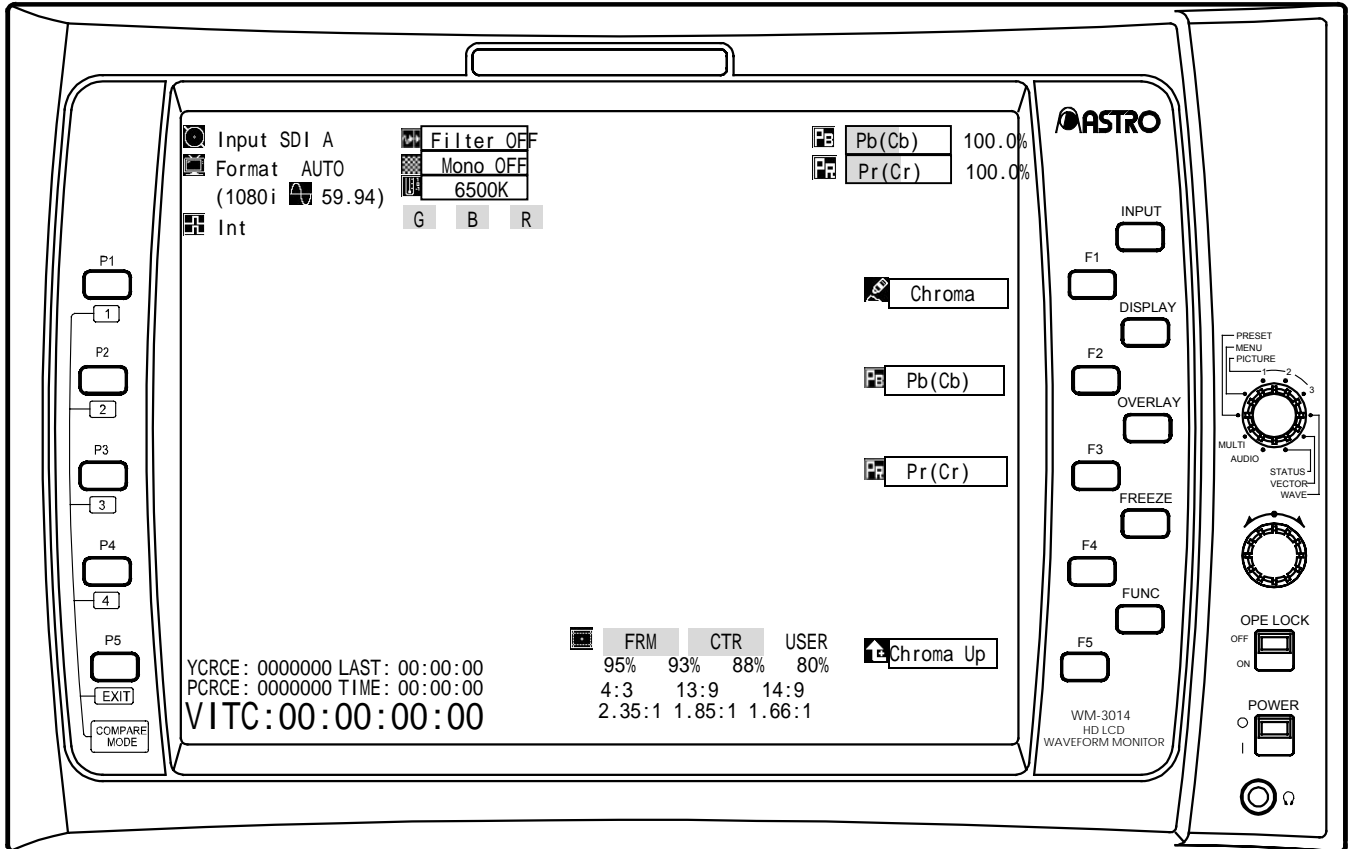

[Description of operations]

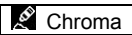
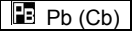
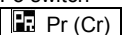
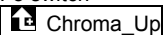
Switch	Description of function
FUNC switch	Use this to return to the function screen. (Refer to section 3.4.1.1.)
F1 switch  Chroma	Use this to adjust the chroma value by turning the adjustment dial. Variable range: 0.0% to 200.0% When the adjustment dial is pressed, the chroma value is returned to the initial value.
F2 switch  Pb (Cb)	Use this to adjust the Pb (Cb) value by turning the adjustment dial. Variable range: 0.0% to 200.0% When the adjustment dial is pressed, the Pb (Cb) value is returned to the initial value.
F3 switch  Pr (Cr)	Use this to adjust the Pr (Cr) value by turning the adjustment dial. Variable range: 0.0% to 200.0% When the adjustment dial is pressed, the Pr (Cr) value is returned to the initial value.
F4 switch	No function.
F5 switch  Chroma Up	This multiplies the chroma signals by 3. * If the result of multiplying the chroma signal value by 3 exceeds $\pm 109\%$, a limit will be imposed at $\pm 109\%$. Example: A 30% signal will be expanded to 90%, but when a 100% signal is multiplied by 3, it will be increased to 109% only.

CAUTION

When the Pb and Pr values differ while the chroma values are being adjusted, once the adjusted chroma for one value reaches 200% or 0%, no further adjustment will be possible for either value.

3.4.1.5 Gamma setting screen

<< Functions >>

The input images are displayed, and the following image adjustments are performed on this screen.

- Y-gamma
- G-gamma
- B-gamma
- R-gamma

<< Screen >>

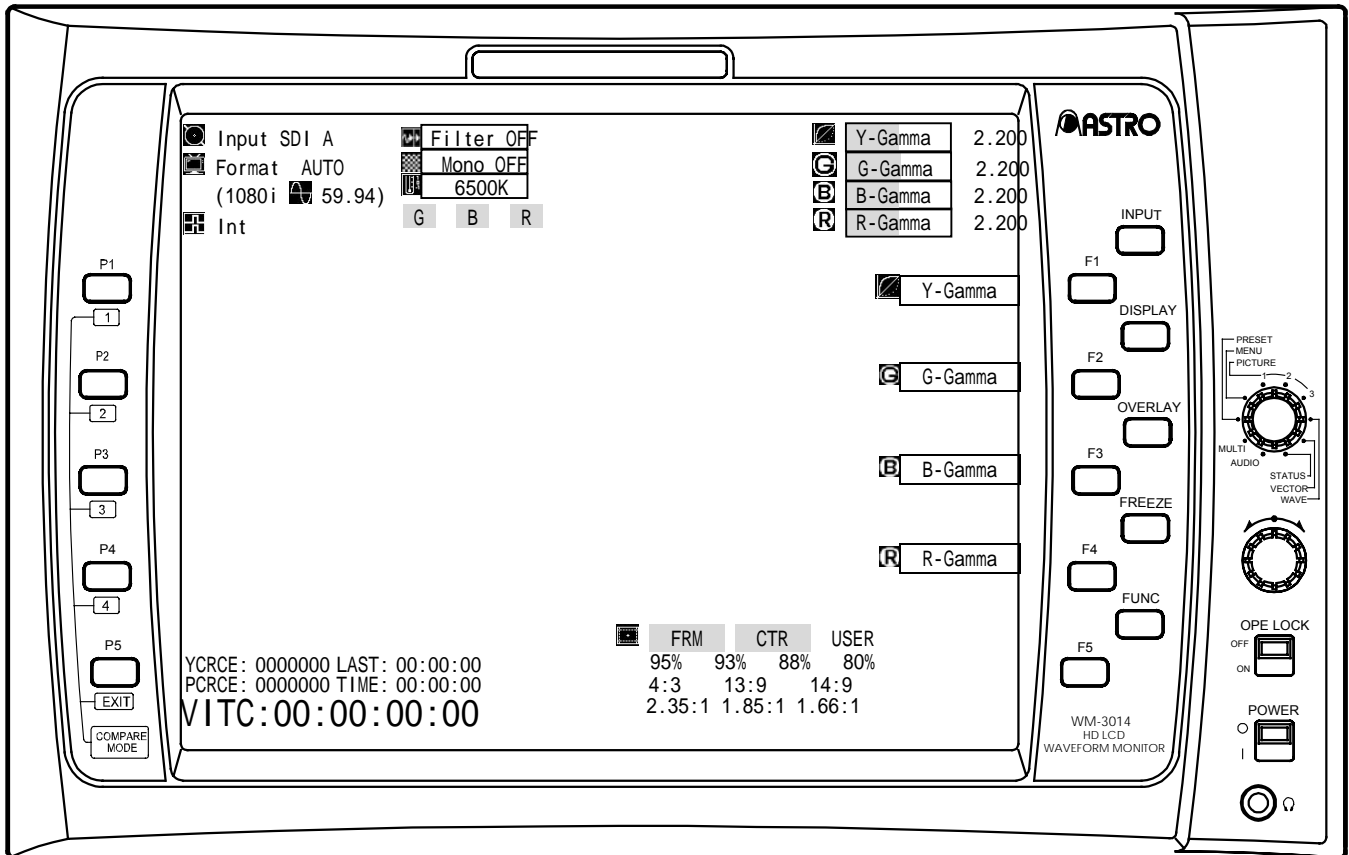

[Description of operations]

Switch	Description of function
FUNC switch	Use this to return to the function screen. (Refer to section 3.4.1.1.)
F1 switch Y-Gamma	Use this to adjust the Y-gamma value by turning the adjustment dial. Variable range: 1.100 to 4.400 When the adjustment dial is pressed, the Y-gamma value is returned to the initial value.
F2 switch G-Gamma	Use this to adjust the G-gamma value by turning the adjustment dial. Variable range: 1.100 to 4.400 When the adjustment dial is pressed, the G-gamma value is returned to the initial value.
F3 switch B-Gamma	Use this to adjust the B-gamma value by turning the adjustment dial. Variable range: 1.100 to 4.400 When the adjustment dial is pressed, the B-gamma value is returned to the initial value.
F4 switch R-Gamma	Use this to adjust the R-gamma value by turning the adjustment dial. Variable range: 1.100 to 4.400 When the adjustment dial is pressed, the R-gamma value is returned to the initial value.
F5 switch	No function.

3.4.1.6 Other image setting screen

<< Functions >>

The input images are displayed, and the following image adjustments are performed on this screen.

- Peaking
- Filter
- Color temperature
- Mask
- Half mask

<< Screen >>

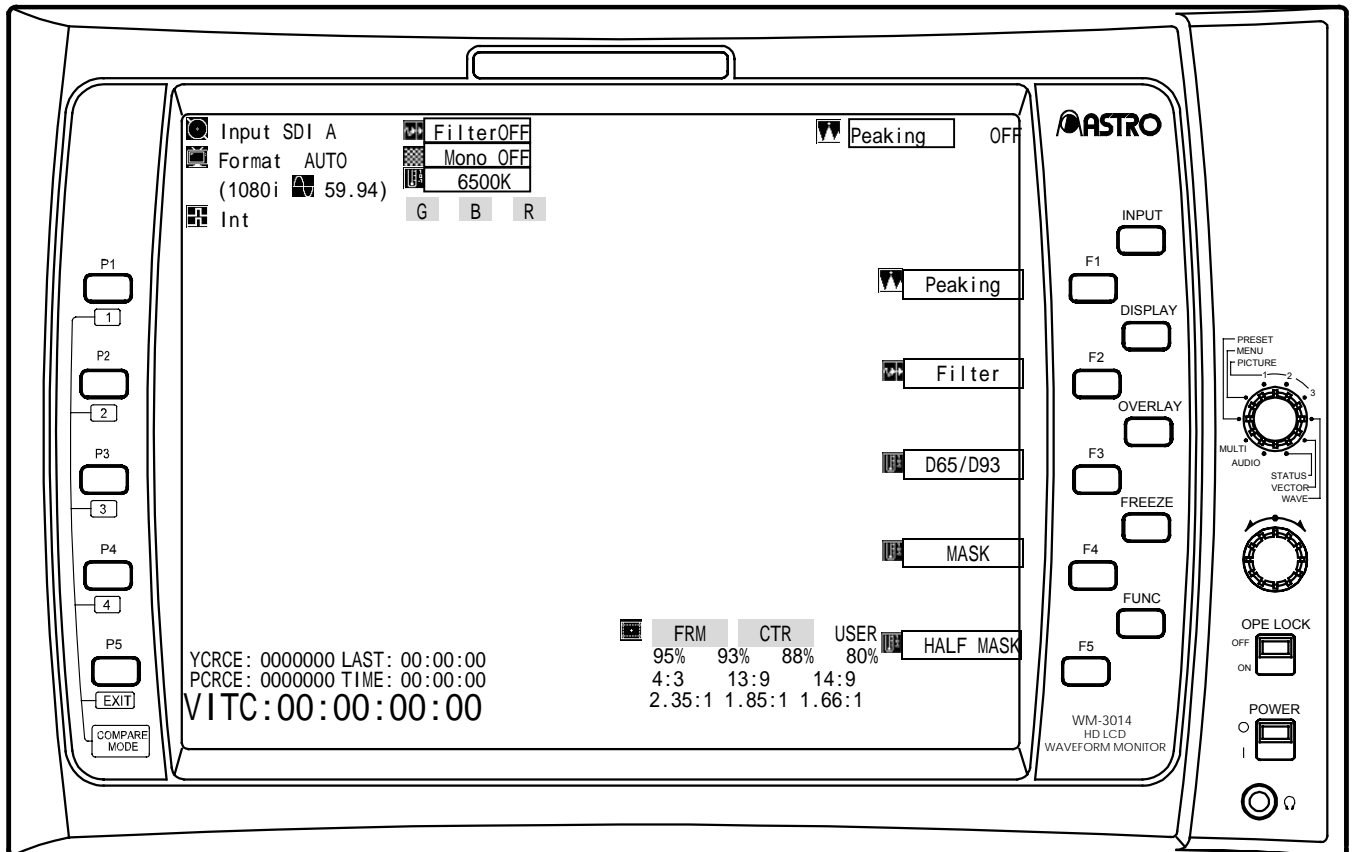

[Description of operations]

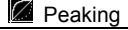
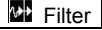
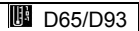
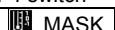
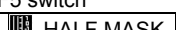
Switch	Description of function
FUNC switch	Use this to return to the function screen. (Refer to section 3.4.1.1.)
F1 switch  Peaking	Use this to adjust the peaking value by turning the adjustment dial. Variable range: OFF, ON (1 to 100) When the adjustment dial is pressed, the peaking value is returned to the initial value.
F2 switch  Filter	Use this to set the filter to ON or OFF.
F3 switch  D65/D93	Use this to set the color temperature to 6500K or 9300K.
F4 switch  MASK	Use this to set the mask function to ON or OFF. (With HD signals)
F5 switch  HALF MASK	Use this to set the half mask function to ON or OFF. (With HD signals)



When the filter is set to ON, the peaking is reset to OFF. Conversely, when the peaking is set to ON, the filter is reset to OFF.

3.4.1.7 Color setting screen

<< Functions >>

By holding down the OVERLAY switch in the PICTURE1 mode, the input images are displayed, and the following settings can be performed.

- Character color
- Marker color

<< Screen >>

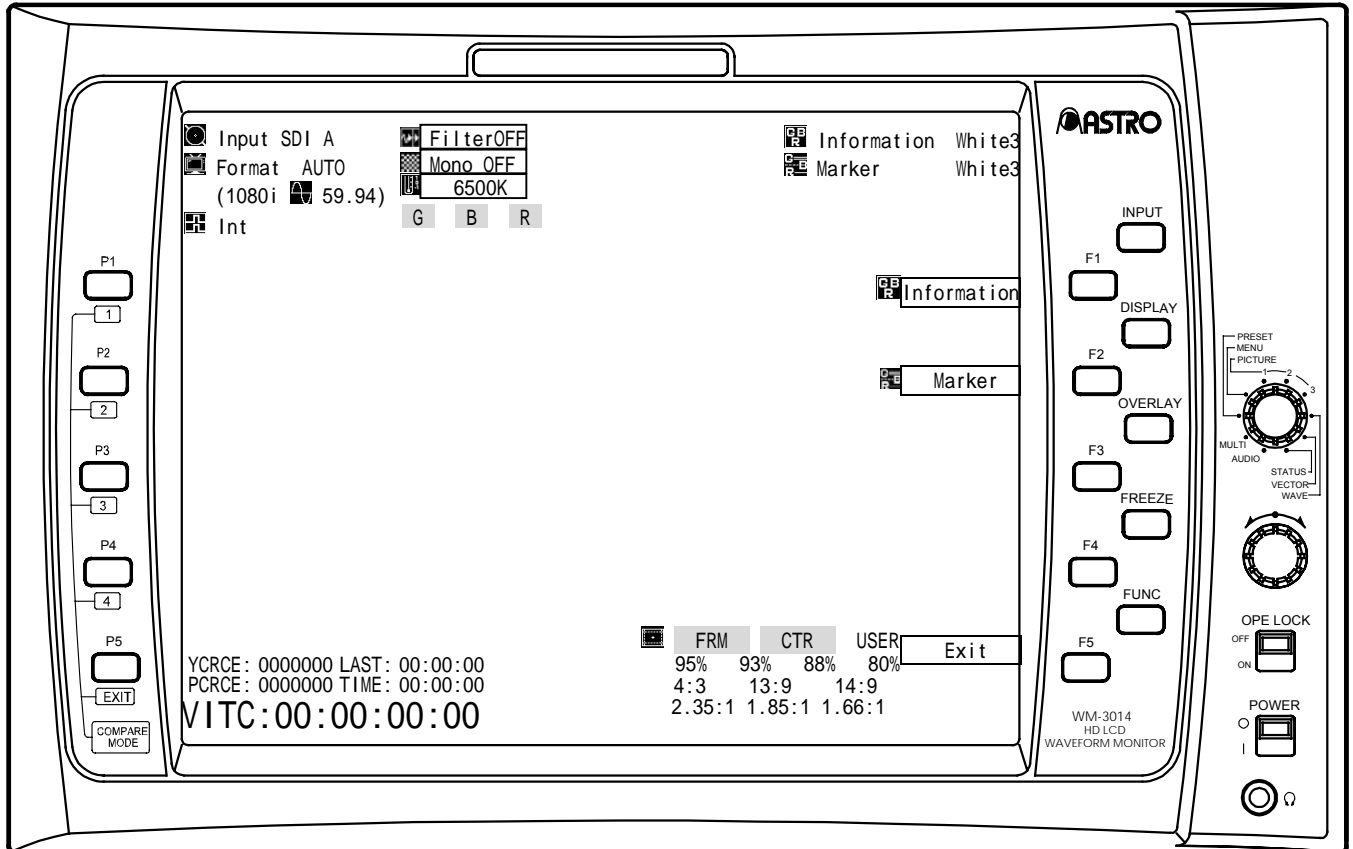

[Description of operations]

Switch	Description of function
FUNC switch	Use this to return to the previous screen.
F1 switch Information	Use this to select the color (any of 63 colors) of the characters by turning the adjustment dial. When the adjustment dial is pressed, the character color is returned to the initial value.
F2 switch Marker	Use this to select the color (any of 64 colors) of the markers by turning the adjustment dial. When the adjustment dial is pressed, the marker color is returned to the initial value.
F3 switch	No function.
F4 switch	No function.
F5 switch Exit	Use this to return to the previous screen.
OVERLAY switch	When this is held down, the display is returned to the previous screen.

3.4.2 PICTUER2 mode

3.4.2.1 Normal screen

<< Functions >>

The input images are displayed, and the following settings can be performed.





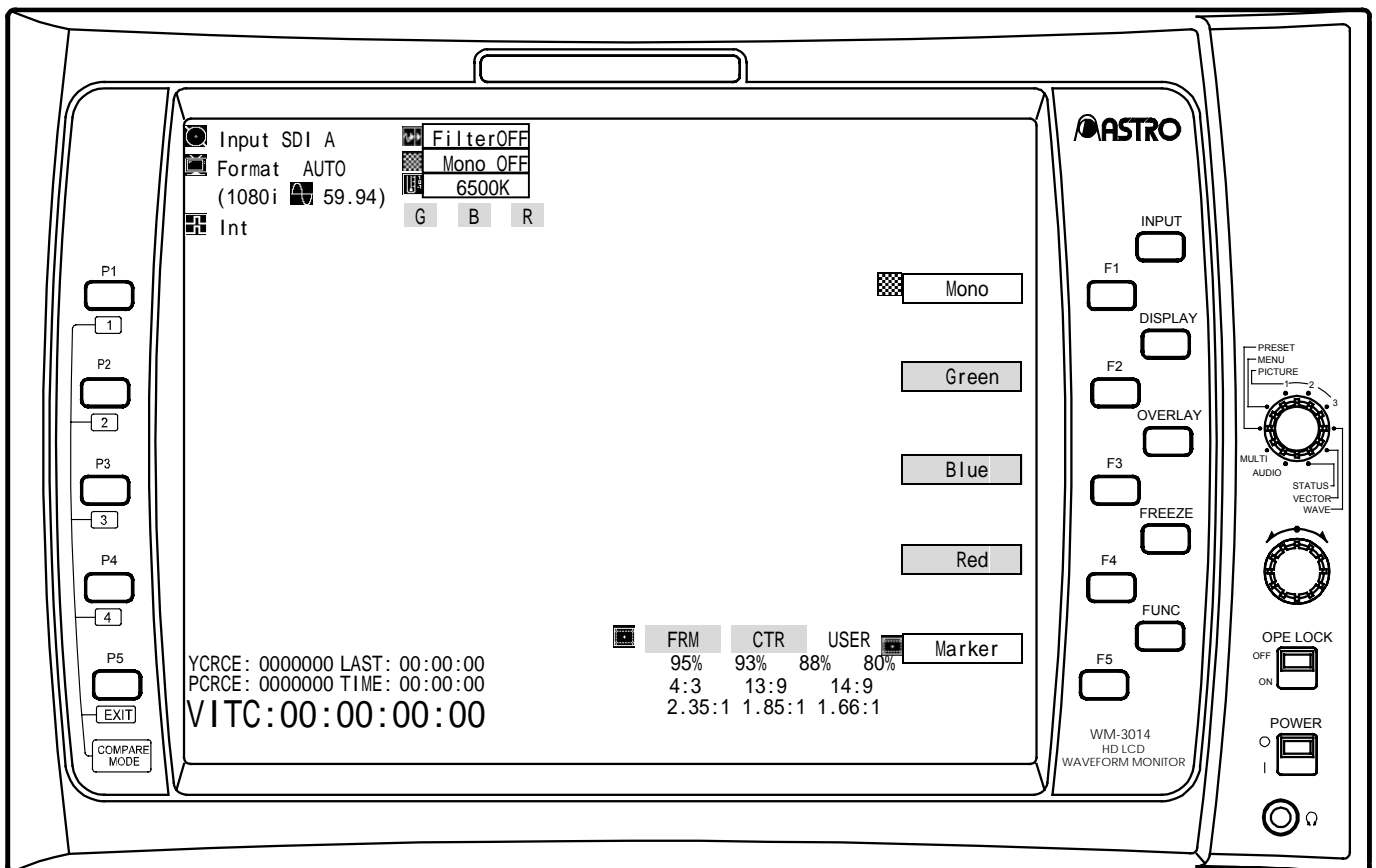

- Monochrome
- G, B AND R ON/OFF
- Markers

Note: With the 525i/60 and 625i/50 formats, the 4:3, 13:9 and 14:9 markers are not displayed. Furthermore, if there are no input signals and **AUTO** has been selected for the format, the 1080 marker is displayed.

<< Screen >>



[Description of operations]

Switch	Description of function
FUNC switch	No function.
F1 switch  Mono	Use this to set monochrome to ON or OFF. When monochrome is set to ON, Green, Blue and Red are set to ON.
F2 switch  Green	Use this to display or not display the green of the input images. If Green is set to OFF while monochrome is ON, monochrome will be set to OFF.
F3 switch  Blue	Use this to display or not display the blue of the input images. If Blue is set to OFF while monochrome is ON, monochrome will be set to OFF.
F4 switch  Red	Use this to display or not display the red of the input images. If Red is set to OFF while monochrome is ON, monochrome will be set to OFF.
F5 switch  Marker	Use this to set the markers to ON or OFF. At the marker ON setting, select the markers using the adjustment dial, and enter the selection by pressing the adjustment dial. Note: With the 525i/60 and 625i/50 formats, the 4:3, 13:9 and 14:9 markers are not displayed. Furthermore, if there are no input signals and  has been selected for the format, the 1080 marker is displayed.

3.4.2.2 User marker setting screen

<< Functions >>

When the F5 switch (Marker switch) is held down in the PICTURE2 mode, the input images are displayed, and the horizontal and vertical values of the user markers can be set.

<< Screen >>

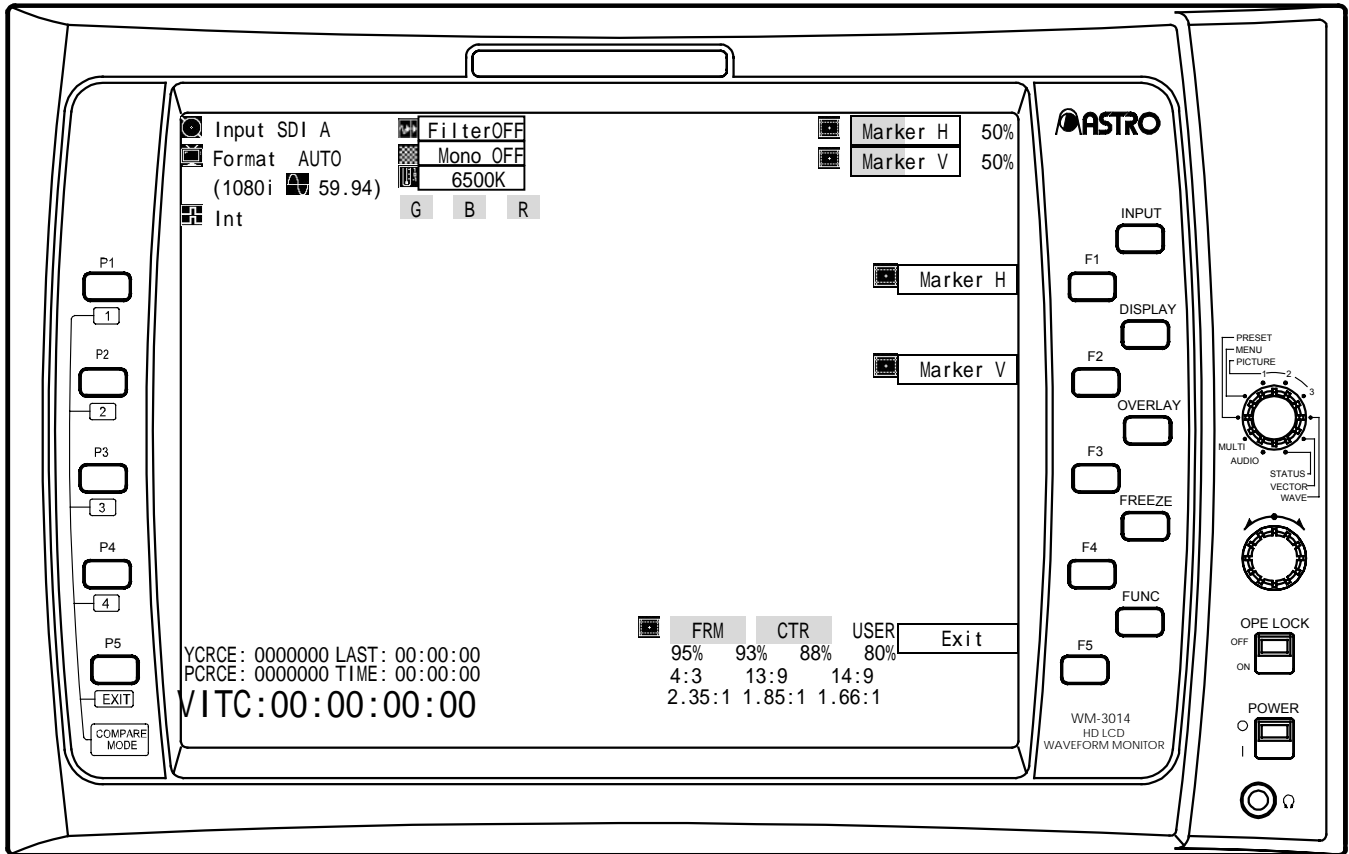

[Description of operations]

Switch	Description of function
FUNC switch	Use this to return to the regular screen. (Refer to section 3.4.2.1.)
F1 switch Marker H	Use this to adjust the horizontal marker value by turning the adjustment dial. When the adjustment dial is pressed, the horizontal marker value is returned to the initial value. Variable range: 0 to 99%
F2 switch Marker V	Use this to adjust the vertical marker value by turning the adjustment dial. When the adjustment dial is pressed, the vertical marker value is returned to the initial value. Variable range: 0 to 99%
F3 switch	No function.
F4 switch	No function.
F5 switch Exit	Use this to return to the regular screen. (Refer to section 3.4.2.1.)

3.4.2.3 Color setting screen

<< Functions >>

When the OVERLAY switch is held down in the PICTURE2 mode, the input pictures are displayed, and the following settings can be performed.

- Character color
- Marker color

<< Color setting screen >>

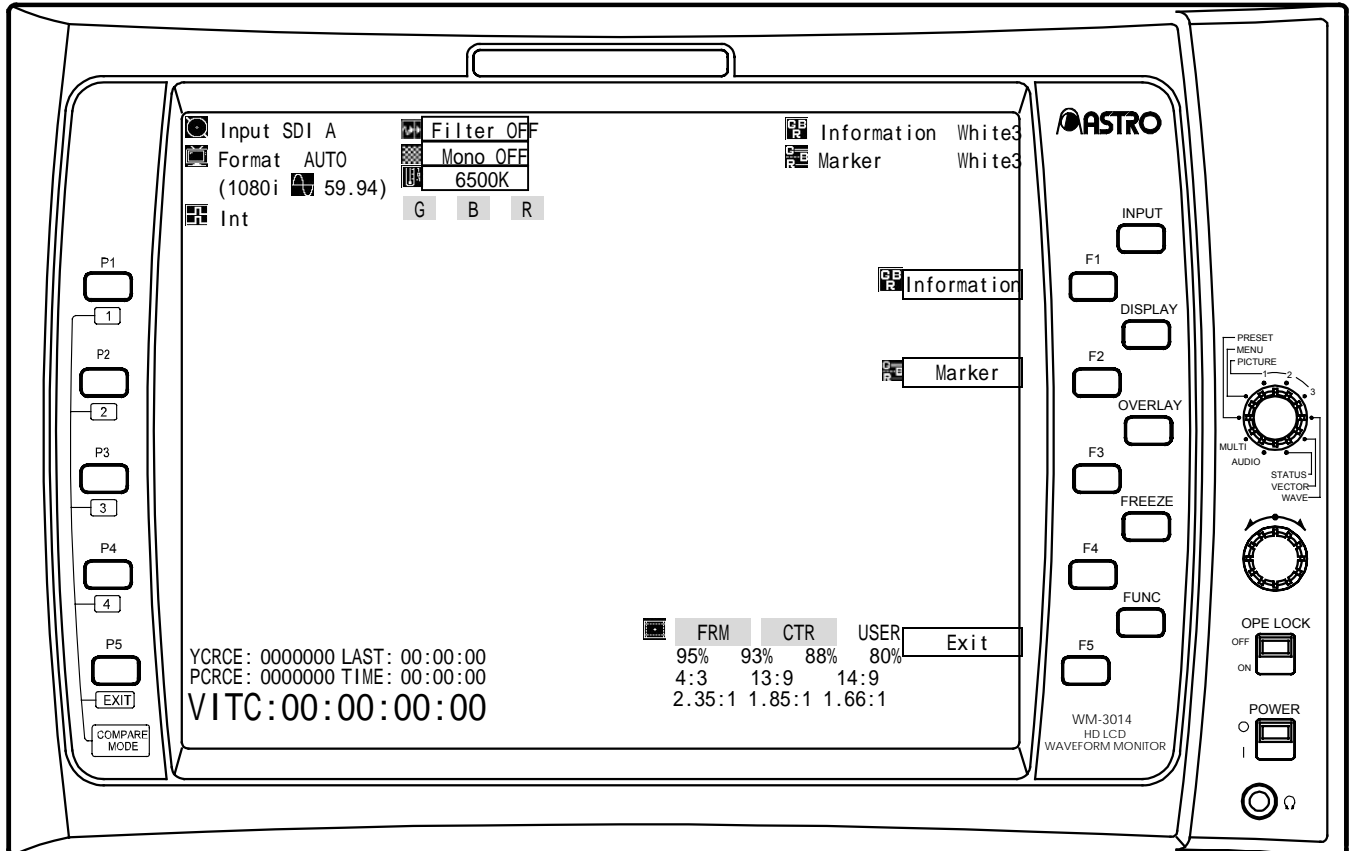

[Description of operations]

Switch	Description of function
FUNC switch	Use this to return to the regular screen. (Refer to section 3.4.2.1.)
F1 switch Information	Use this to select the color (any of 63 colors) of the characters by turning the adjustment dial. When the adjustment dial is pressed, the character color is returned to the initial value.
F2 switch Marker	Use this to select the color (any of 64 colors) of the markers by turning the adjustment dial. When the adjustment dial is pressed, the marker color is returned to the initial value.
F3 switch	No function.
F4 switch	No function.
F5 switch Exit	Use this to return to the regular screen. (Refer to section 3.4.2.1.)
OVERLAY switch	When this is held down, the display is returned to the regular screen. (Refer to section 3.4.2.1.)

3.4.3 PICTURE3 mode

3.4.3.1 Regular screen

<< Functions >>

The input images are displayed, and the following settings can be performed.

- H Delay
- V Delay
- MAG

<< Screen >>

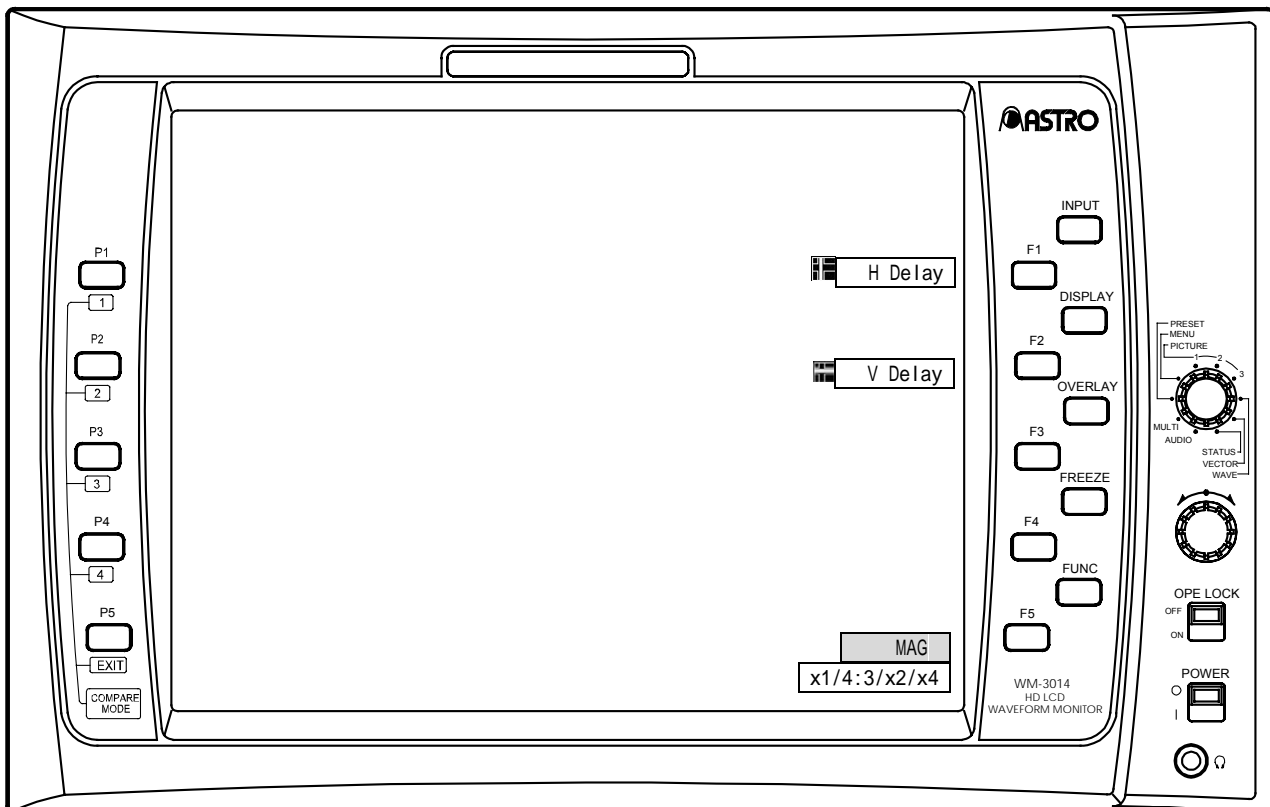

[Description of operations]

Switch	Description of function
FUNC switch	No function.
F1 switch H Delay	Use this to set the H Delay to ON or OFF. Even when ON is selected as the H Delay setting here, the setting will return to OFF once the PICTURE3 mode is exited.
F2 switch V Delay	Use this to set the V Delay to ON or OFF. Even when ON is selected as the V Delay setting here, the setting will return to OFF once the PICTURE3 mode is exited.
F3 switch	No function.
F4 switch	No function.
F5 switch MAG x1 / 4:3 / x2 / x4	Use this to select x1, 4:3, x2 or x4 for HD signals or x1, 4:3, 16:9 or x4 for SD signals as the magnification ratio. Even when 4:3, x2 or x4 is selected as the MAG setting here, the setting will return to x1 once the PICTURE3 mode is exited.

3.4.3.2 Color setting screen

<< Functions >>

When the OVERLAY switch is held down in the PICTURE3 mode, the following settings can be performed on this screen.

- Character color
- Marker color

<< Screen >>

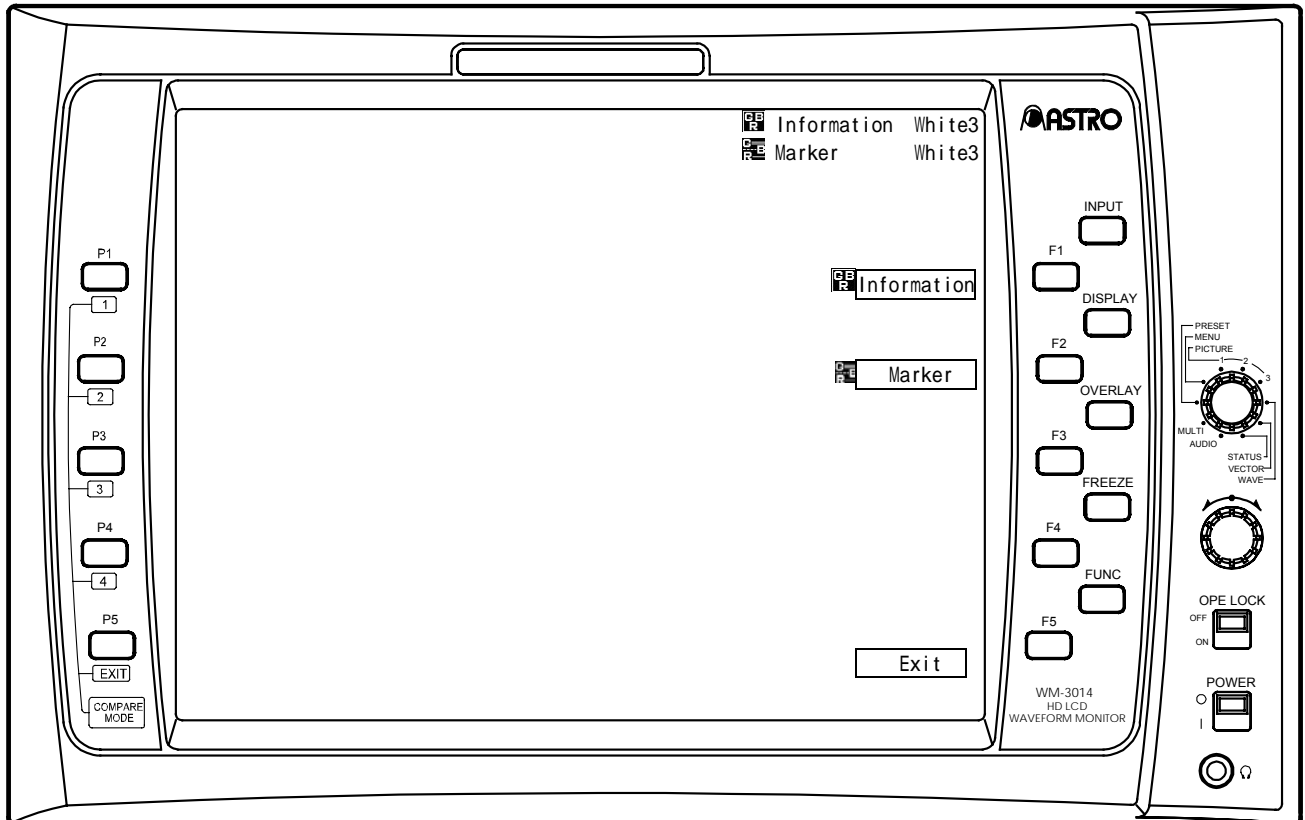

[Description of operations]

Switch	Description of function
FUNC switch	Use this to return to the regular screen. (Refer to section 3.4.3.1.)
F1 switch Information	Use this to select the color (any of 63 colors) of the characters by turning the adjustment dial. When the adjustment dial is pressed, the character color is returned to the initial value.
F2 switch Marker	Use this to select the color (any of 64 colors) of the markers by turning the adjustment dial. When the adjustment dial is pressed, the marker color is returned to the initial value.
F3 switch	No function.
F4 switch	No function.
F5 switch Exit	Use this to return to the regular screen. (Refer to section 3.4.3.1.)
OVERLAY switch	When this is held down, the display is returned to the regular screen. (Refer to section 3.4.3.1.)

3.4.4 WAVEFORM mode

3.4.4.1 Function screen

<< Functions >>

The waveforms are displayed on this screen.

* When composite signals are input, the data after the signals have been converted into component signals is displayed. In regard to the PAL signals, however, the waveforms of the 3 lines each at the start and end of the video signals will be more disturbed than in actuality.

<< Screen >>

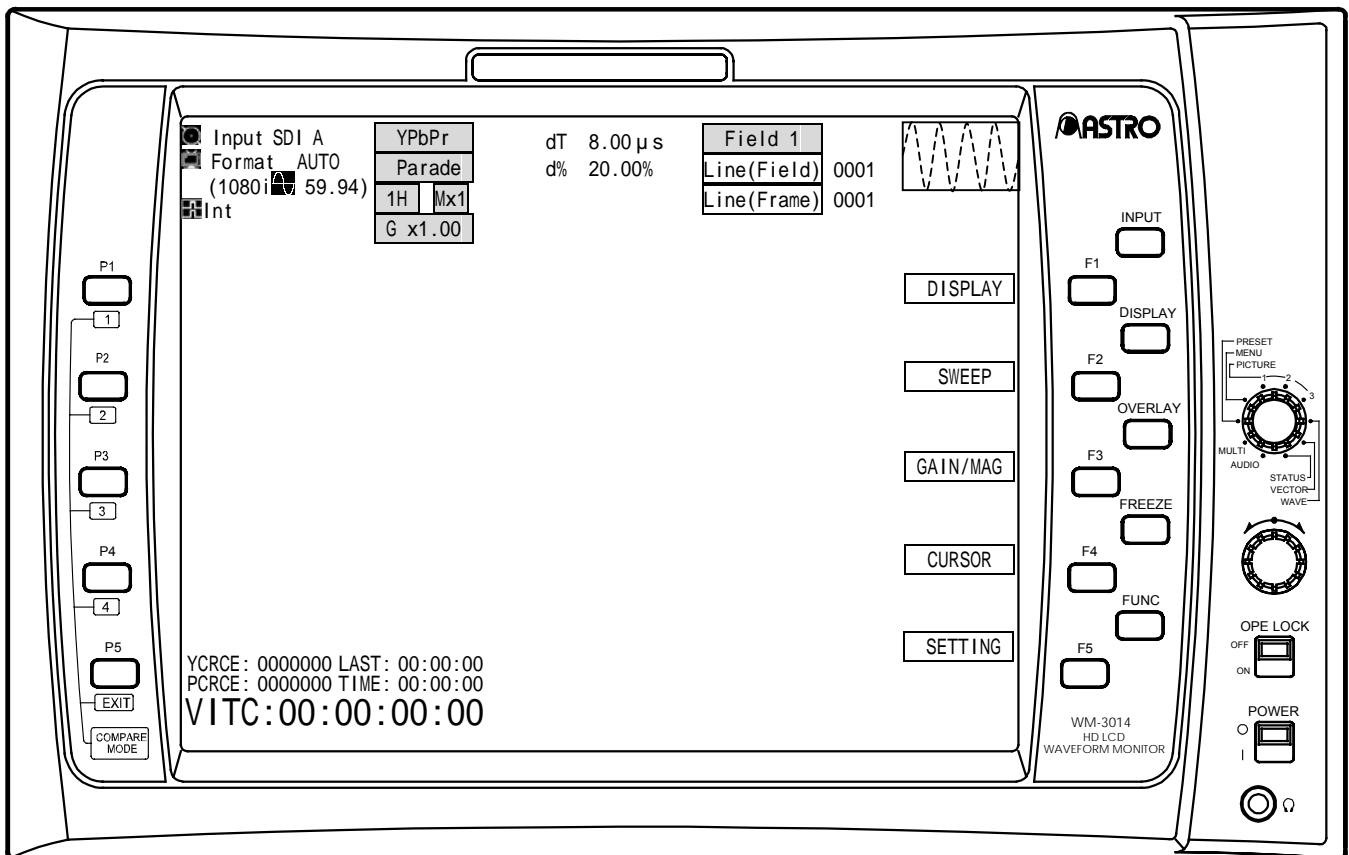

[Description of operations]

Switch	Description of function
FUNC switch	Use this to return to the previous screen.
Adjustment dial	No function.
F1 switch DISPLAY	Use this to set the display to the DISPLAY setting screen. (Refer to section 3.4.4.2.)
F2 switch SWEEP	Use this to set the display to the SWEEP setting screen. (Refer to section 3.4.4.3.)
F3 switch GAIN/MAG	Use this to set the display to the GAIN/MAG setting screen. (Refer to section 3.4.4.4.)
F4 switch CURSOR	Use this to set the display to the CURSOR setting screen. (Refer to section 3.4.4.5.)
F5 switch SETTING	Use this to set the display to the WAVEFORM mode setting screen. (Refer to section 3.4.4.6.)

3.4.4.2 DISPLAY setting screen

<< Functions >>

The waveforms are displayed, and the following settings can be performed on this screen.

- Switching between parade display (side-by-side display) and overlay display (superimposed display) for the waveforms
- Line select function (with 1H, 2H)

<< Screen >>

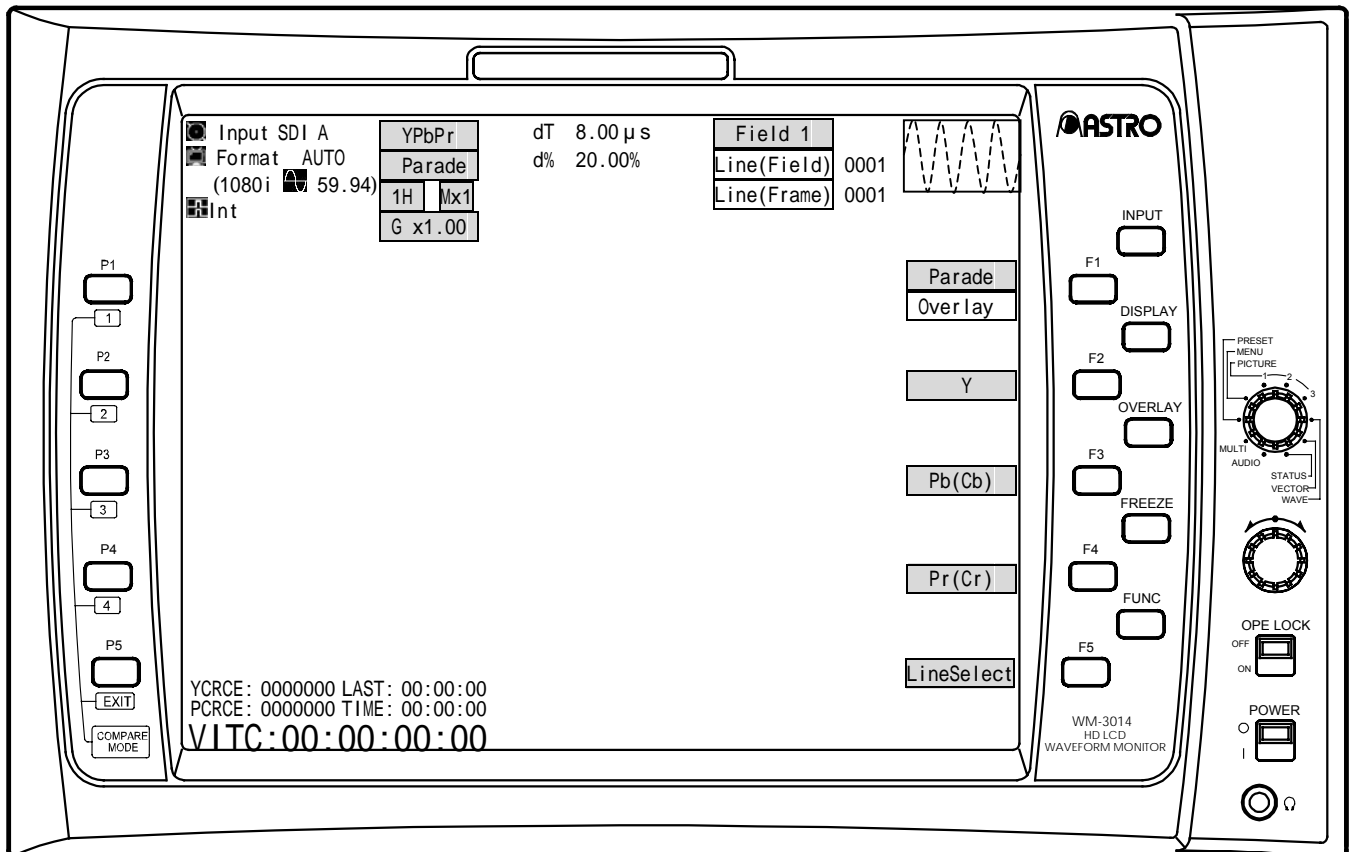

[Description of operations]

Switch	Description of function
FUNC switch	Use this to return to the function screen. (Refer to section 3.4.4.1.)
F1 switch Parade / Overlay	Use this to switch between parade display (side-by-side display) and overlay display (superimposed display) for the waveforms.
F2 switch Y	Use this to set Y / G to ON or OFF.
F3 switch Pb (Cb)	Use this to set Pb / B to ON or OFF.
F4 switch Pr (Cr)	Use this to set Pr / R to ON or OFF.
F5 switch LineSelect	Use this to set line select to ON or OFF. When line select is ON, the lines are incremented or decremented by turning the adjustment dial, and the field is switched by pressing the adjustment dial. The line select ON/OFF and line settings are coupled in the WAVEFORM mode and VECTOR mode. (This applies with 1H or 2H only; field switching is enabled only with the interlacing or segmented frame format.)

3.4.4.3 SWEEP setting screen

<< Functions >>

The waveforms are displayed, and the following settings can be performed on this screen.

- 1H, 2H, 1F or 2F display switching
- Line select function (with 1H, 2H)

<< Screen >>

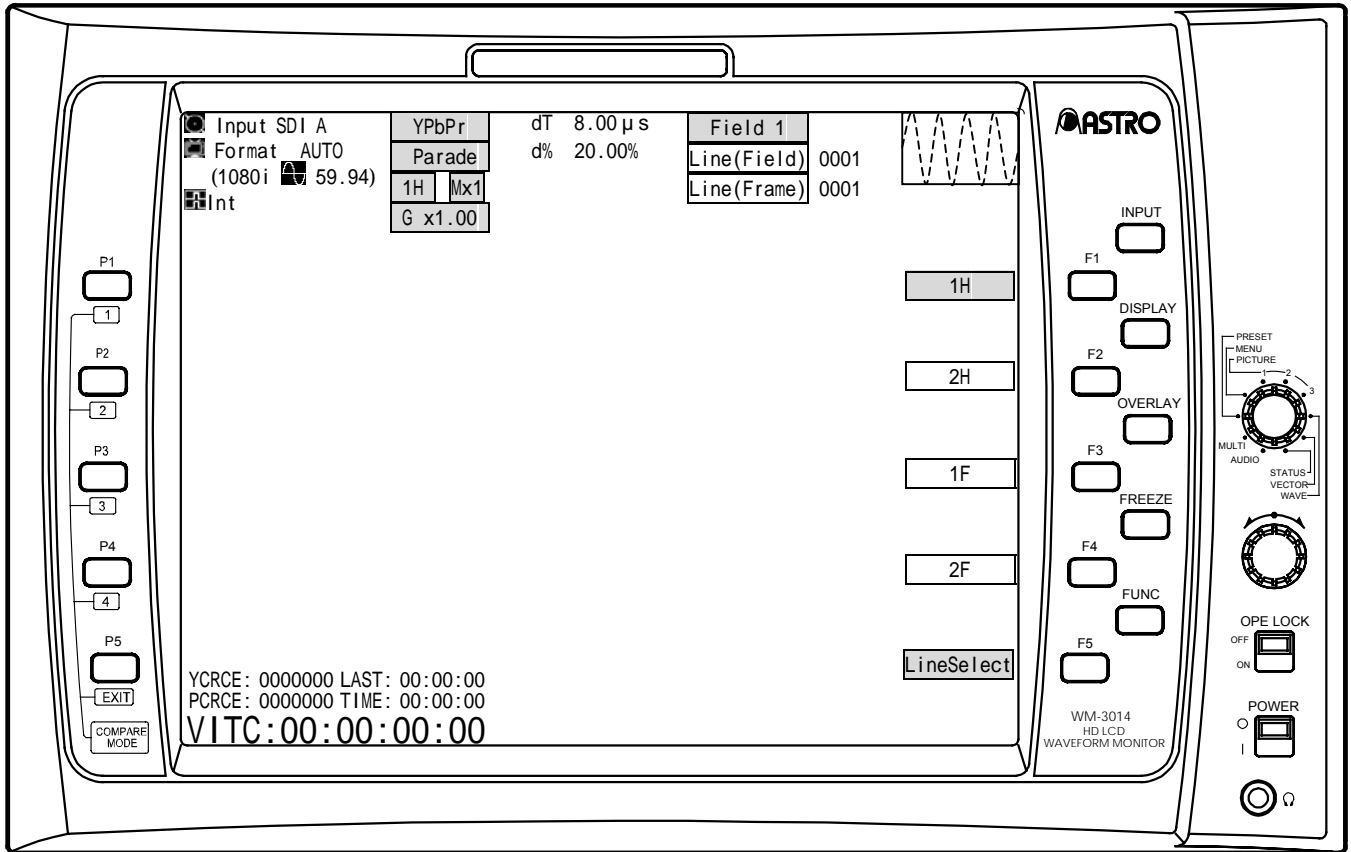

[Description of operations]

Switch	Description of function
FUNC switch	Use this to return to the function screen. (Refer to section 3.4.4.1.)
F1 switch 1H	Use this to set the 1H display.
F2 switch 2H	Use this to set the 2H display (with the interlacing or segmented frame format). In the line select OFF status, the odd-numbered fields are displayed on the left side, and the even-numbered fields are displayed on the right side. In the line select ON status, the selected line is displayed on the left side, and the next line in the selected field is displayed on the right side.
F3 switch 1F	Use this to set the 1H display. The horizontal blanking data is not displayed.
F4 switch 2F	Use this to set the 2H display (with the interlacing or segmented frame format). The odd-numbered fields are displayed on the left side, and the even-numbered fields are displayed on the right side. The horizontal blanking data is not displayed.
F5 switch LineSelect	Use this to set line selection to ON or OFF. In the line select ON status, the lines are incremented or decremented by turning the adjustment dial, and the field is switched by pressing the adjustment dial. The line select ON/OFF and line settings are coupled in the WAVEFORM mode and VECTOR mode. (This applies with 1H or 2H only; field switching is enabled only with the interlacing or segmented frame format.)

3.4.4.4 GAIN/MAG setting screen

<< Functions >>

The waveforms are displayed, and the following settings can be performed on this screen.

- Gain ($\times 0.03$ to $\times 7.97$), MAG ($1\times$, $2\times$ or $4\times$) setting
- Scroll functions

<< Screen >>

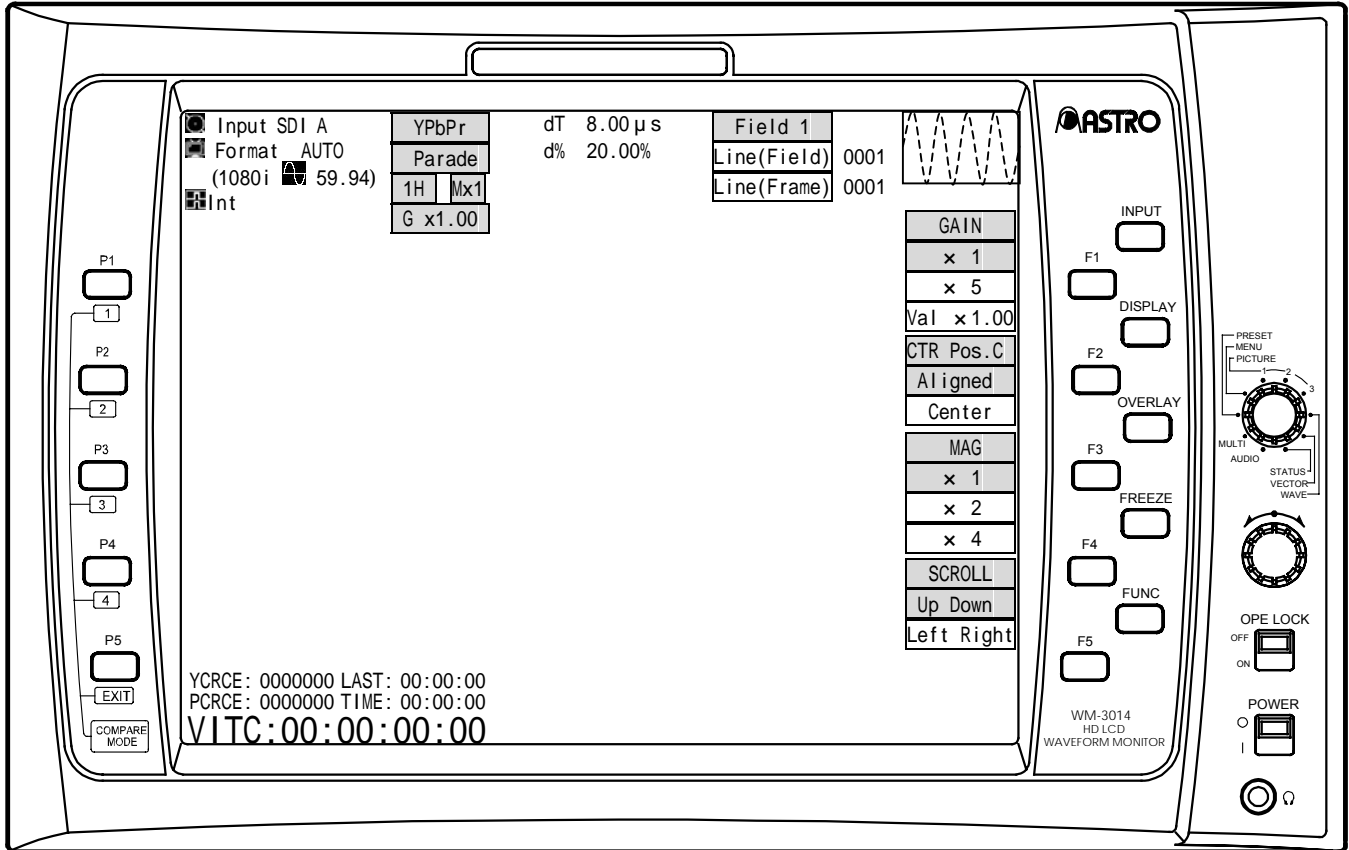

[Description of operations]

Switch	Description of function	
FUNC switch	Use this to return to the function screen. (Refer to section 3.4.4.1.)	
Turning the adjustment dial	When The Gain Setting Is Fixed <input type="checkbox"/> ×1 / <input type="checkbox"/> ×5	No function.
	When the gain setting is variable <input type="checkbox"/> Val ×*. **	Turn the dial to set the magnification rate of the gain. (Variable range: 0.03 to 7.97)
	When scrolling	Turn the dial to scroll vertically (up/down) or horizontally (left/right).
Pressing the adjustment dial	When the gain setting is fixed <input type="checkbox"/> ×1 / <input type="checkbox"/> ×5	No function.
	When the gain setting is variable <input type="checkbox"/> Val ×*. **	The gain is set to an integral value after the decimal places have been rounded down (with a figure of 4 or below) or rounded up (with a figure of 5 or above). (All values below 0.49 are set to 0.03; similarly, all values above 7.00 are set to 7.00.) If the gain magnification rate is an integer, it is increased in 1.00 increments, and when 7.00 is reached, it is returned to 1.00.)
	When scrolling	Press the dial to reset the scrolling.
F1 switch <input type="checkbox"/> GAIN ×1 / <input type="checkbox"/> GAIN ×5 / <input type="checkbox"/> GAIN Val ×*. **	Use this to switch the gain magnification rate (×1 / ×5) or switch the adjustment dial function to the gain setting (Val ×*. **).	
F2 switch <input type="checkbox"/> CTR Pos.C Aligned / <input type="checkbox"/> CTR Pos.C Center	Use this to switch the position where the Pb (Cb) and Pr (Cr) signals are to be displayed when the gain is magnified. The setting is fixed at <input type="checkbox"/> Aligned when GBR is selected on the waveform display. (Refer to section 3.2.4.6.)	
F3 switch <input type="checkbox"/> MAG ×1 / <input type="checkbox"/> MAG ×2 / <input type="checkbox"/> MAG ×4	Use this to select the MAG magnification rate (1×, 2× or 4×).	
F4 switch <input type="checkbox"/> Scroll Up Down / <input type="checkbox"/> Scroll Left Right	Use this to select vertical (up/down) or horizontal (left/right) for scrolling. If H Blank is not ON when 1H or 2H has been selected or if 1F or 2F has been selected, the horizontal blanking data will not be displayed even when the display is scrolled horizontally. (For details on 1H, 2H, 1F and 2F, refer to section 3.4.4.3.)	
F5 switch	No function.	

3.4.4.5 CURSOR setting screen

<< Functions >>

The waveforms are displayed, and the following settings can be performed on this screen.

- H and V cursor display and difference display (mV, μ s)

<< Screen >>

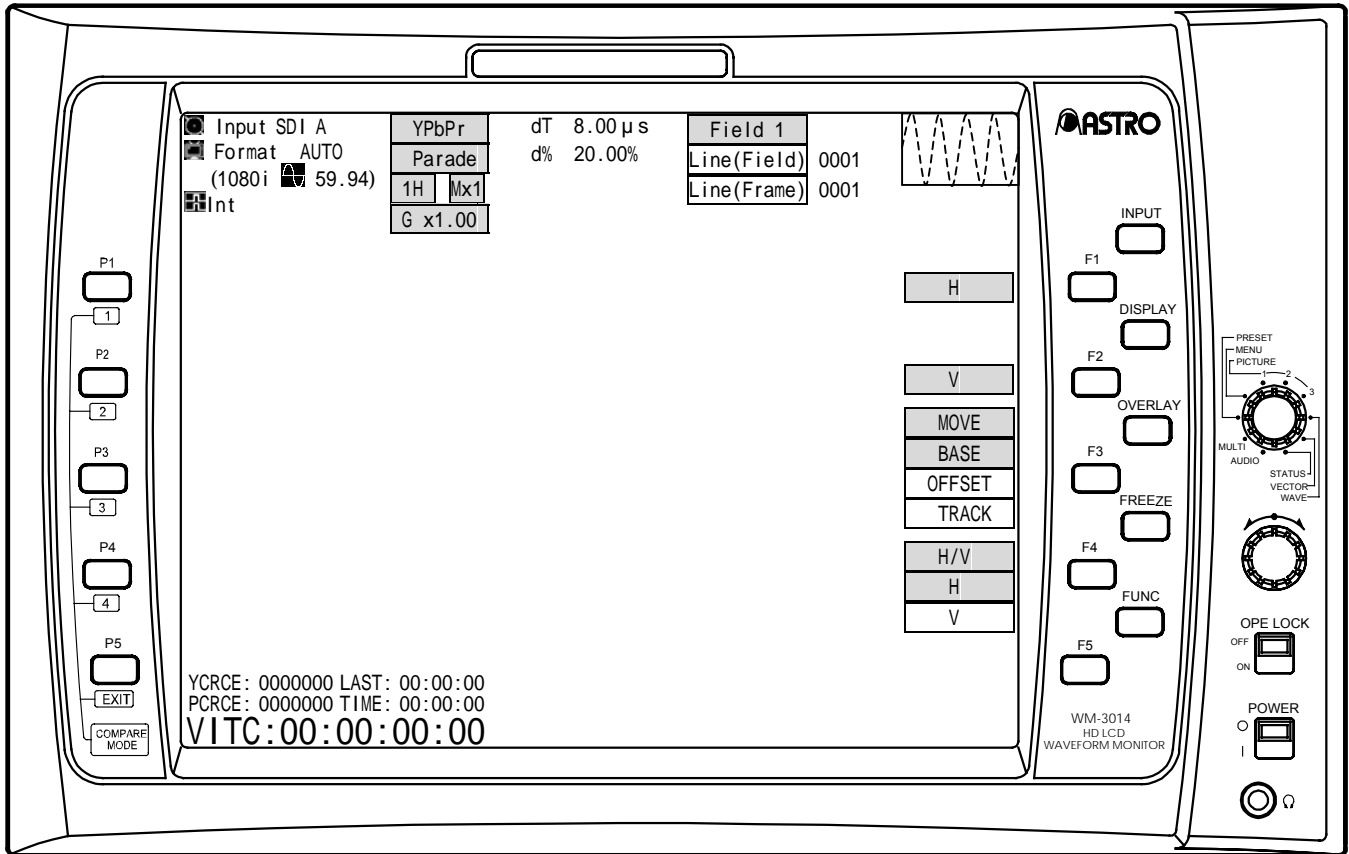

[Description of operations]

Switch	Description of function
FUNC switch	Use this to return to the function screen. (Refer to section 3.4.4.1.)
Adjustment dial	Use this to move the cursor horizontally or vertically.
F1 switch H	Use this to set the display of the H cursor to ON or OFF.
F2 switch V	Use this to set the display of the V cursor to ON or OFF.
F3 switch MOVE BASE / MOVE OFFSET / MOVE TRACK	Use this to select the cursor (BASE, OFFSET or TRACK) to be moved.
F4 switch H/V H / H/V V	Use this to select the cursor (H or V) to be moved.
F5 switch	No function.

3.4.4.6 SETTING mode setting screen

<< Functions >>

The waveforms are displayed, and the following settings can be performed on this screen.

- Waveform display YPbPr/GBR/RGB switching
- V Ancillary (Wave) and H Blanking switching
- Scale switching
- Filter selection

<< Screen >>

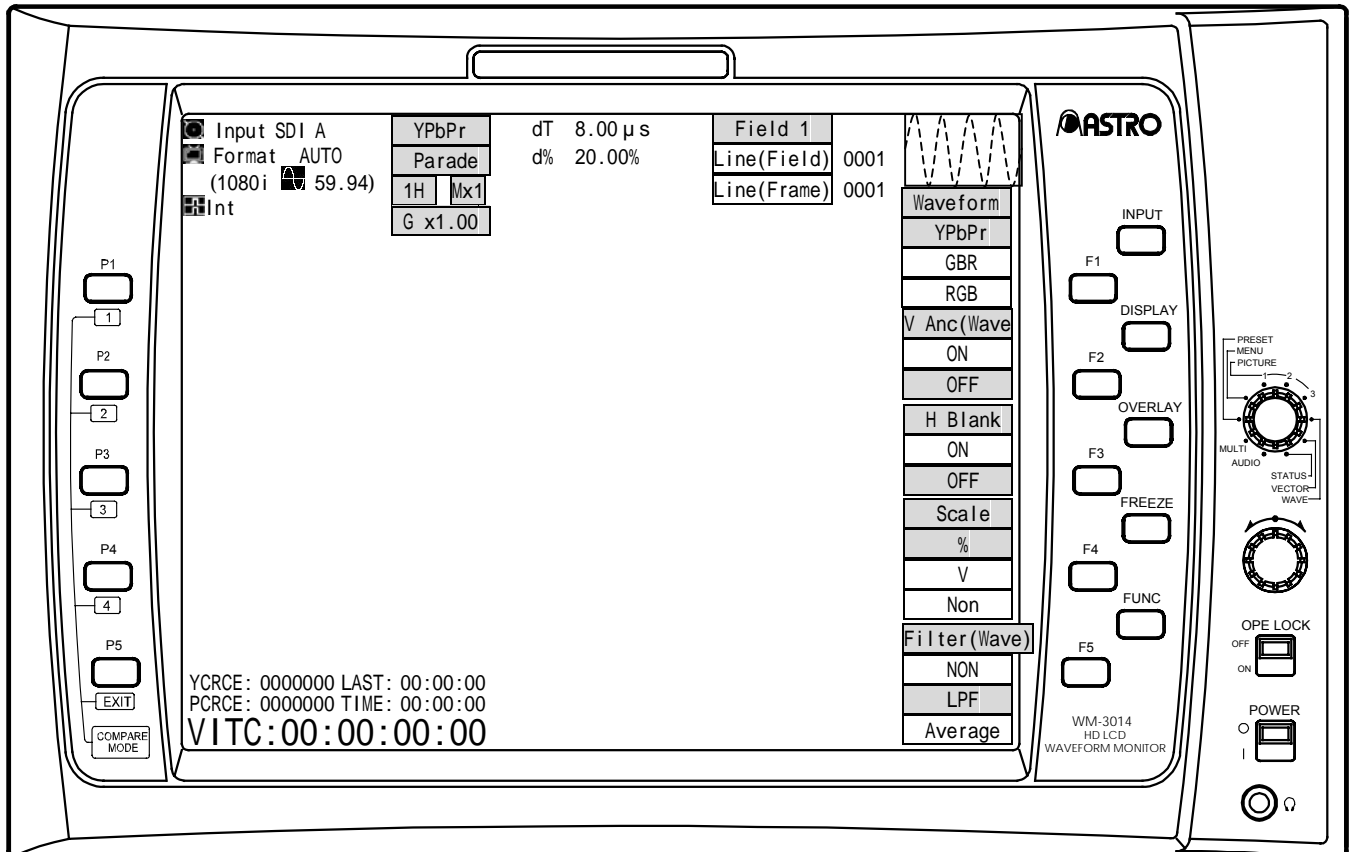

[Description of operations]

Switch	Description of function
FUNC switch	Use this to return to the function screen. (Refer to section 3.4.4.1.)
Adjustment dial	No function.
F1 switch Waveform YPbPr / Waveform GBR / Waveform RGB	Use this to switch between YPbPr, GBR and RGB for the waveform display.
F2 switch V Anc ON / V Anc OFF	Use this to set V ancillary to ON or OFF. This takes effect only when the WAVEFORM mode is established.
F3 switch H Blank ON / H Blank OFF	Use this to set H Blanking to ON or OFF. To view the H blanking waveforms, set to ON, and set the scroll to horizontal. (For details on horizontal scrolling, refer to section 3.4.4.4.)
F4 switch Scale % / Scale V / Scale Non	Use this to switch the scale units between %, V and no display.
F5 switch Filter (Wave) NON / Filter (Wave) LPF / Filter (Wave) Average	Use this to select filter (Wave) or no filter and set the type of filter. This takes effect only when the WAVEFORM mode is established. LPF frequency characteristics Y: 6 MHz (-3 dB), PbPr: 3 MHz (-3 dB) "Average" is obtained by averaging the data for 8 pixels immediately before and after.

3.4.4.7 Color setting screen

<< Functions >>

When the OVERLAY switch is held down in the WAVEFORM mode, the following settings can be performed on this screen.

- Character color
- Scale color
- Waveform color and brightness
- Cursor color

<< Screen >>

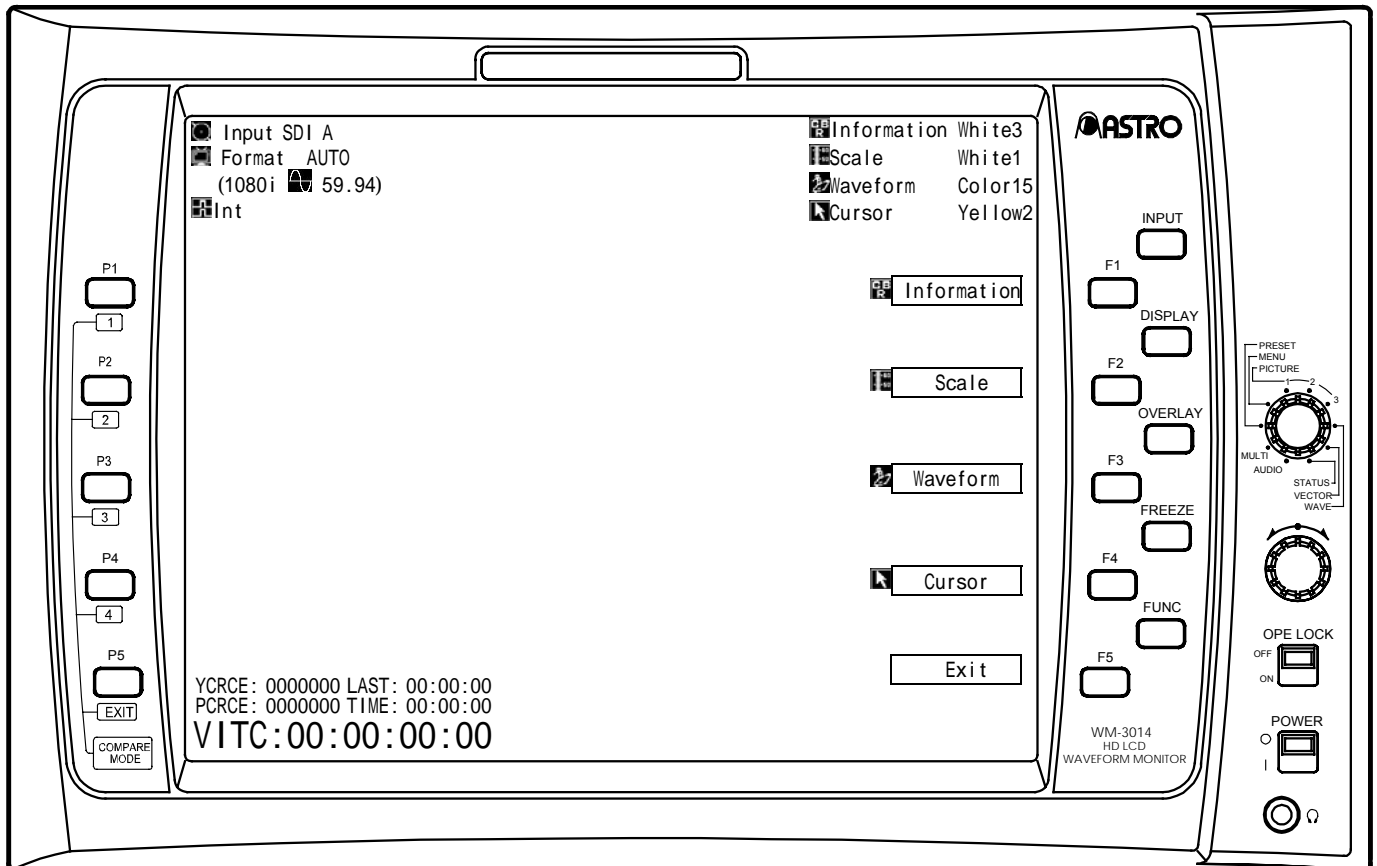

[Description of operations]

Switch	Description of function
FUNC switch	Use this to return to the previous screen.
F1 switch Information	Use this to select the color (any of 63 colors) of the characters by turning the adjustment dial. When the adjustment dial is pressed, the character color is returned to the initial value.
F2 switch Scale	Use this to select the color (any of 63 colors) of the scale by turning the adjustment dial. When the adjustment dial is pressed, the scale color is returned to the initial value.
F3 switch Waveform	Use this to select the color (any of 62 colors) and brightness of the waveform by turning the adjustment dial. When the adjustment dial is pressed, the waveform color is returned to the initial value.
F4 switch Cursor	Use this to select the color (any of 63 colors) of the cursor by turning the adjustment dial. When the adjustment dial is pressed, the cursor color is returned to the initial value.
F5 switch Exit	Use this to return to the previous screen.
OVERLAY switch	When this is held down, the display is returned to the previous screen.

3.4.5 VECTOR mode

3.4.5.1 Regular screen

<< Functions >>

The signals on the vectorscope can be displayed, and the following settings can be performed on the screen.

- Enlargement of vectorscope display
- Line select function
- When composite signals are input, the data after the signals have been converted into component signals is displayed. In regard to the PAL signals, however, the waveforms of the 3 lines each at the start and end of the video signals will be more disturbed than in actuality.

<< Screen >>

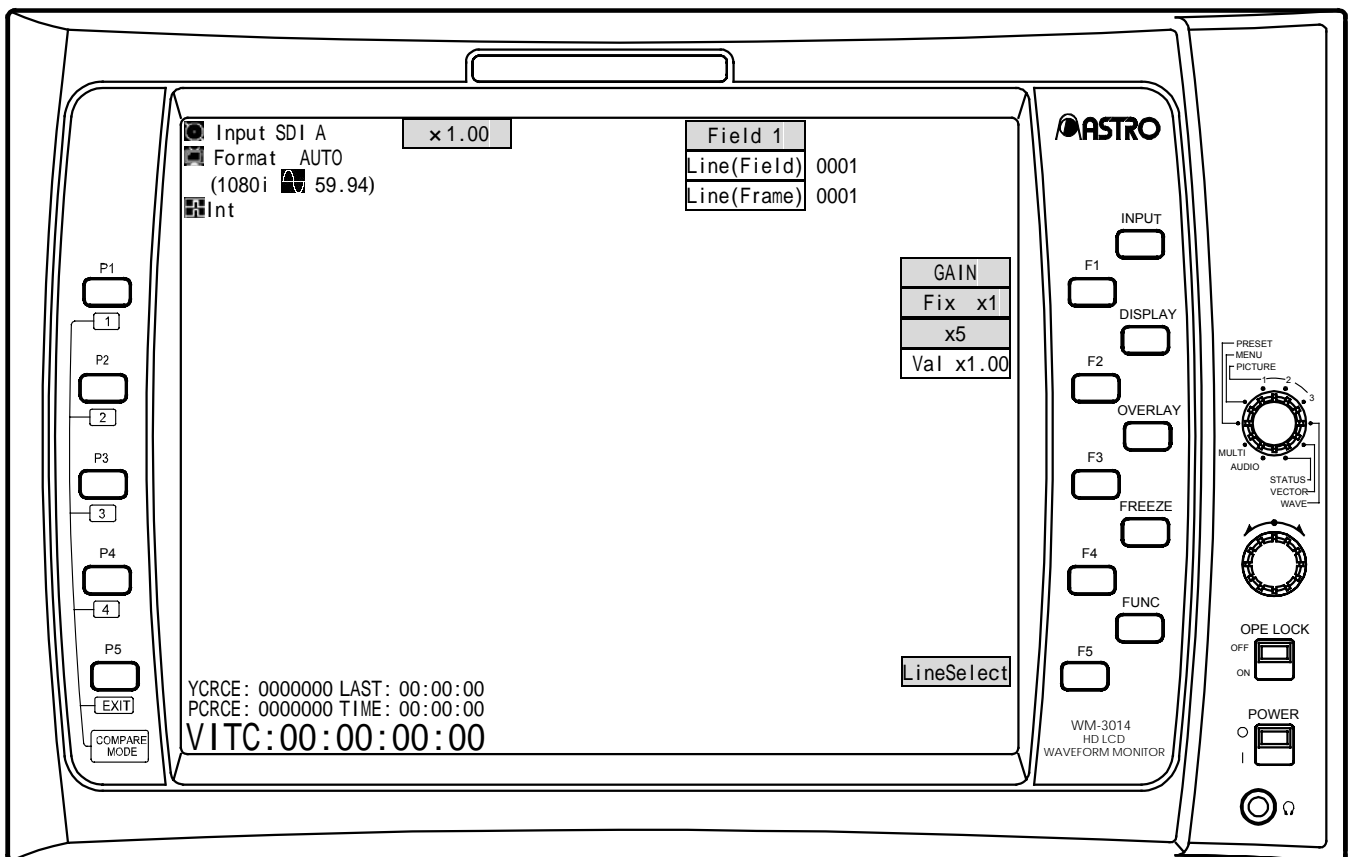

[Description of operations]

Switch	Description of function	
FUNC switch	Use this to switch the display to the VECTOR mode setting screen. (Refer to section 3.4.7.2.)	
Turning the adjustment dial	When the gain setting is fixed <input type="checkbox"/> Fix $\times 1 / \times 5$	No function.
	When the gain setting is variable <input type="checkbox"/> Val $\times^{*} .^{**}$	Turn the dial to set the magnification rate of the gain. (Variable range: 0.03 to 7.97)
	When line select is ON	Turn the dial to increment or decrement the lines. The line select ON/OFF and line settings are linked in the WAVEFORM mode and VECTOR mode.
Pressing the adjustment dial	When the gain setting is fixed <input type="checkbox"/> Fix $\times 1 / \times 5$	No function.
	When the gain setting is variable <input type="checkbox"/> Val $\times^{*} .^{**}$	The gain is an integral value after the decimal places have been rounded down (with a figure of 4 or below) or rounded up (with a figure of 5 or above). (All values below 0.49 are set to 0.03; similarly, all values above 7.00 are set to 7.00.) If the gain magnification rate is an integer, it is increased in 1.00 increments, and when 7.00 is reached, it is returned to 1.00.
	When line select is ON	Use the switch to select the field. (Field switching applies only with the interlacing or segmented frame format.)
F1 switch <input type="checkbox"/> GAIN <input type="checkbox"/> Fix $\times 1$ / <input type="checkbox"/> GAIN <input type="checkbox"/> $\times 5$ / <input type="checkbox"/> GAIN <input type="checkbox"/> Val $\times^{*} .^{**}$	Use this switch to set line select to OFF and to switch between the fixed (Fix $\times 1 / \times 5$) and variable ($\times^{*} .^{**}$) gain setting. In the Fix $\times 1$ status, the loci between the pixels are interpolated for the display; in other statuses, only the points are displayed.	
F2 switch	No function.	
F3 switch	No function.	
F4 switch	No function.	
F5 switch <input type="checkbox"/> LineSelect	Use this to set line select to ON or OFF. When line select is ON, the gain setting display is fixed (Fix $\times 1$).	

3.4.5.2 VECTOR mode setting screen

<< Functions >>

The signals on the vectorscope can be displayed, and the following settings can be performed on the screen.

- V Ancillary (Vect) switching
- Scale switching
- LPF (Vect) switching

<< Screen >>

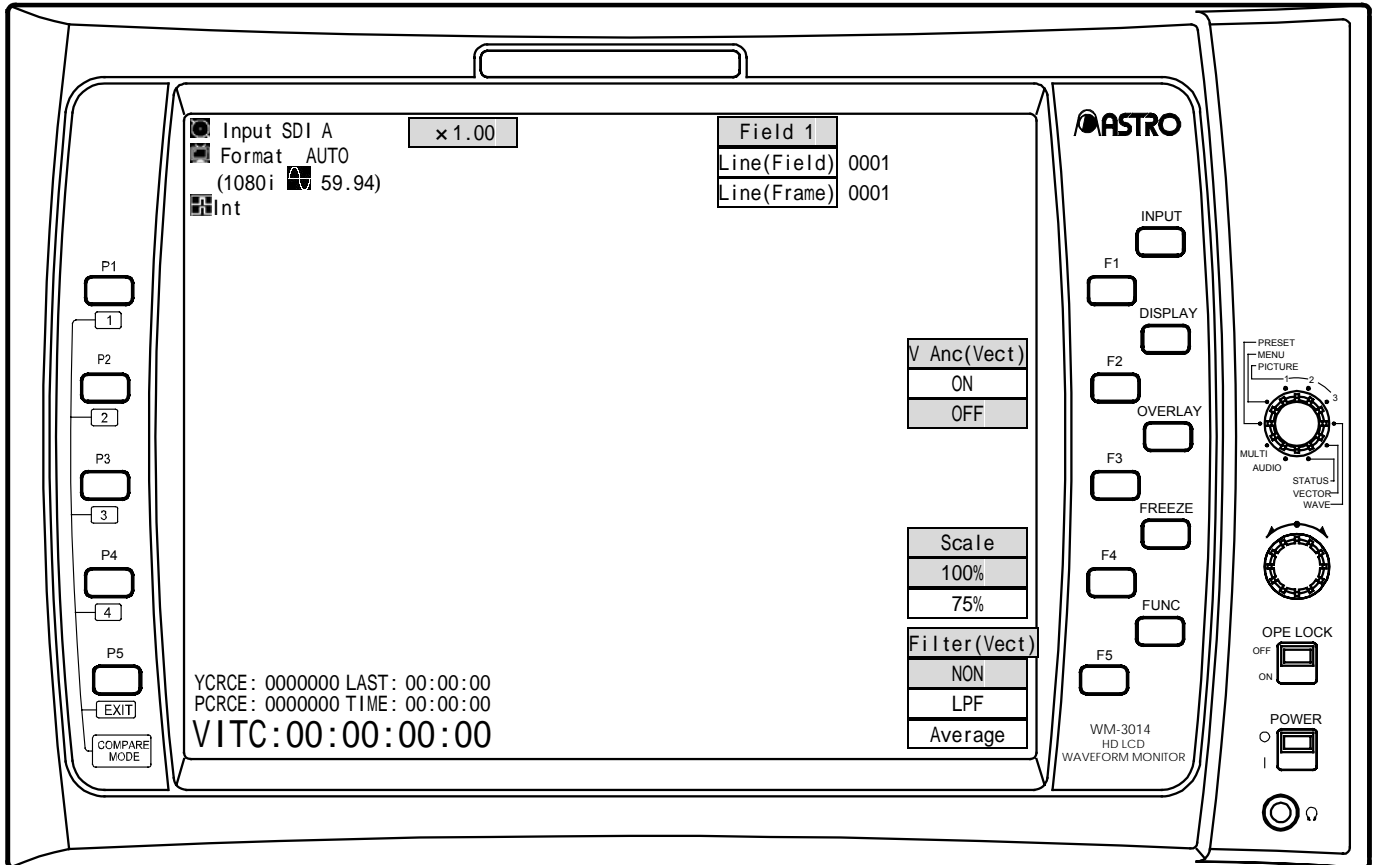

[Description of operations]

Switch	Description of function
FUNC switch	Use this to display the regular screen. (Refer to section 3.4.7.1.)
Adjustment dial	No function.
F1 switch	No function.
F2 switch V Anc (Vect) ON / V Anc (Vect) OFF	Use this to set V ancillary to ON or OFF. This takes effect only when the VECTOR mode is established.
F3 switch	No function.
F4 switch Scale 100% / Scale 75%	Use this to switch the scale between 100% and 75%.
F5 switch Filter (Vect) NON / Filter (Vect) LPF / Filter (Vect) Average	Use this to set to filter (Wave) or no filter and set the type of filter. This takes effect only when the VECTOR mode is established. LPF frequency characteristics Y : 6MHz (-3db), PbPr : 3MHz (-3db) "Average" is the average of the data of the 8 pixels immediately before and after.

3.4.5.3 Color setting screen

<< Functions >>

When the OVERLAY switch is held down in the VECTOR mode, the following settings can be performed on this screen.

- Character color
- Scale color
- Vector color and brightness
- Cursor color

<< Screen >>

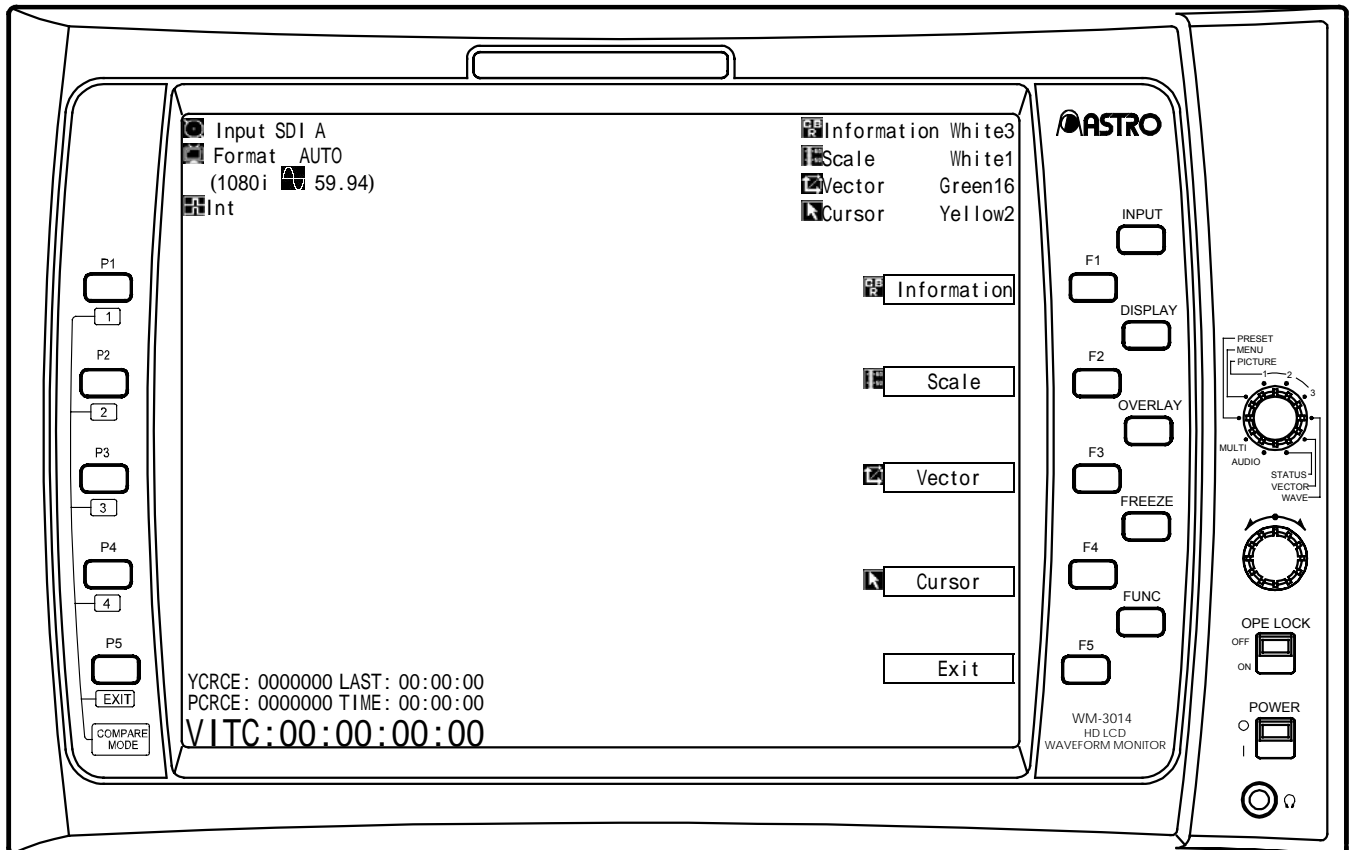

[Description of operations]

Switch	Description of function
FUNC switch	Use this to return to the previous screen.
F1 switch Information	Use this to select the color (any of 63 colors) of the characters by turning the adjustment dial. When the adjustment dial is pressed, the character color is returned to the initial value.
2 switch Scale	Use this to select the color (any of 63 colors) of the scale by turning the adjustment dial. When the adjustment dial is pressed, the scale color is returned to the initial value.
F3 switch Vector	Use this to select the color (any of 160 colors) and brightness of the vector by turning the adjustment dial. When the adjustment dial is pressed, the vector color is returned to the initial value.
F4 switch Cursor	Use this to select the color (any of 63 colors) of the cursor by turning the adjustment dial. When the adjustment dial is pressed, the cursor color is returned to the initial value.
F5 switch Exit	Use this to return to the previous screen.
OVERLAY switch	When this is held down, the display is returned to the previous screen.

3.4.6 STATUS mode

3.4.6.1 Regular screen

<< Functions >>

The signals on the status can be displayed, and the following settings can be performed on the screen.

- Status (numerical value) display
- EAV/SAV display

<< Screen >>

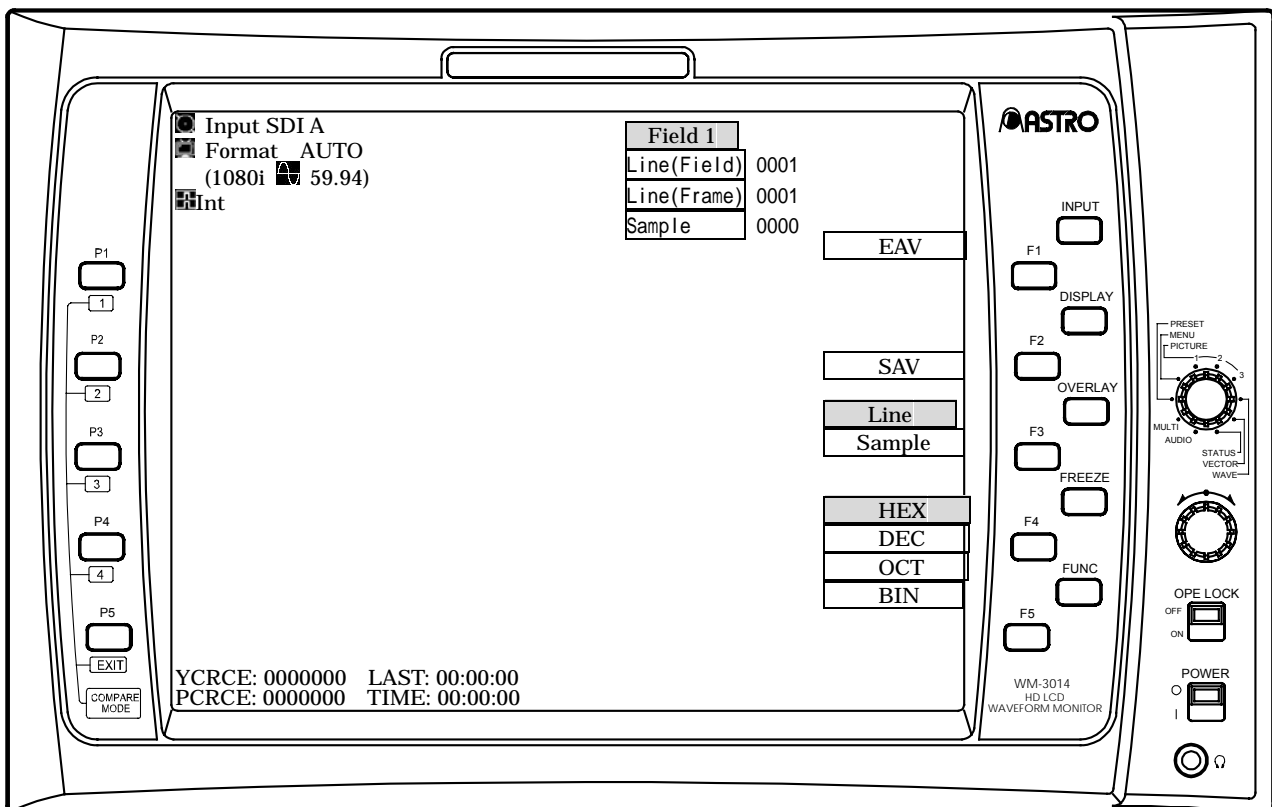

[Description of operations]

Switch	Description of function
FUNC switch	(Not used)
Turning the adjustment dial	Turn the dial to increment or decrement the lines or samples of the status displayed. The lines are linked in the WAVEFORM mode, VECTOR mode and STATUS mode.
Pressing the adjustment dial	Use this to switch the fields. (with the interlacing or segmented frame format).
F1 switch EAV	Use this to jump to EAV.
F2 switch SAV	Use this to jump to SAV.
F3 switch Line / Sample	Turn the adjustment dial, and use this to switch the item (Line or Sample) to be set.
F4 switch HEX / DEC / OCT / BIN	Use this to switch the cardinal number of the data to be displayed to HEX (hexadecimal), DEC (decimal), OCT (octal) or BIN (binary).
F5 switch	No function.

3.4.6.2 Color setting screen

<< Functions >>

When the OVERLAY switch is held down in the STATUS mode, the following settings can be performed on this screen.

- Character color
- Scale color
- Status color
- Cursor color

<< Screen >>

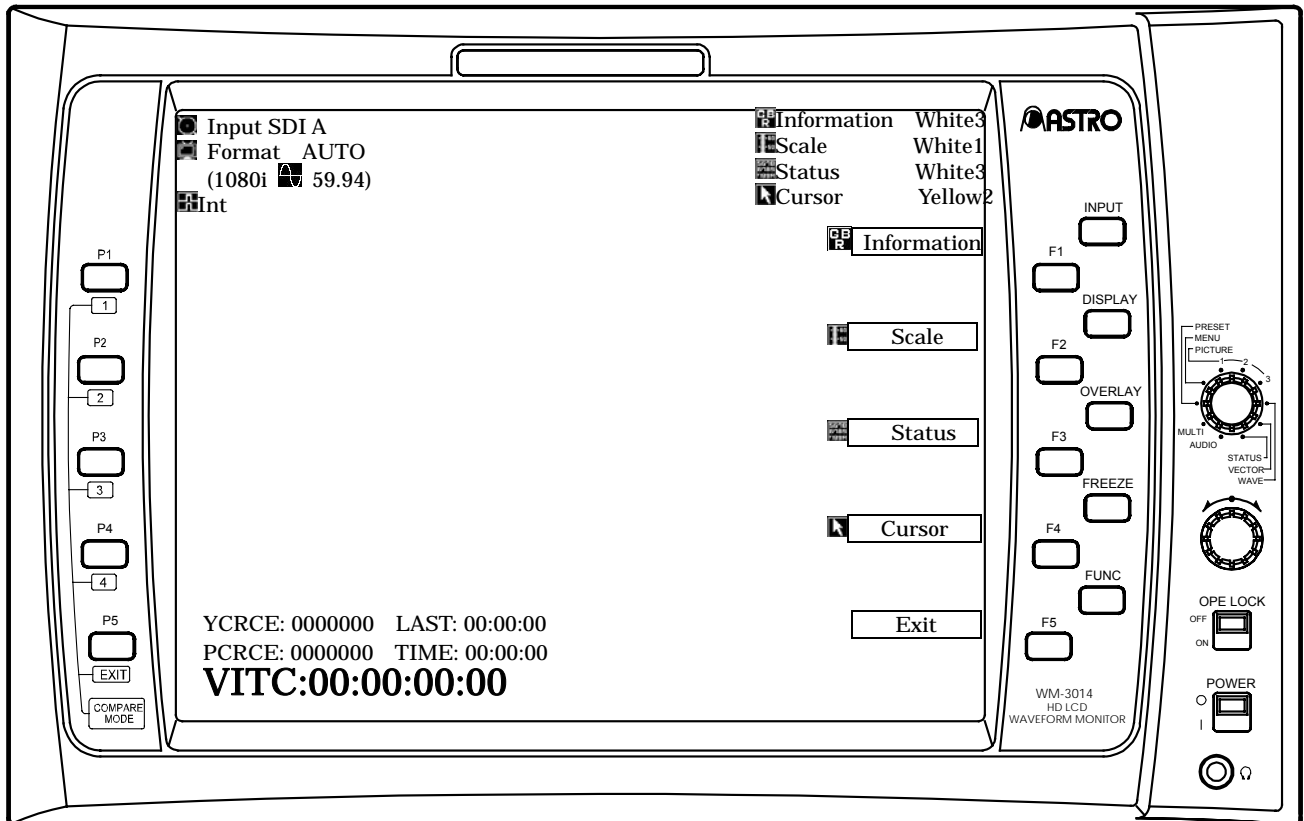

[Description of operations]

Switch	Description of function
FUNC switch	Use this to return to the regular screen. (Refer to section 3.4.6.1.)
F1 switch Information	Use this to select the color (any of 63 colors) of the characters by turning the adjustment dial. When the adjustment dial is pressed, the character color is returned to the initial value.
F2 switch Scale	Use this to select the color (any of 63 colors) of the scale by turning the adjustment dial. When the adjustment dial is pressed, the scale color is returned to the initial value.
F3 switch Status	Use this to select the color (any of 63 colors) of the status by turning the adjustment dial. When the adjustment dial is pressed, the status color is returned to the initial value.
F4 switch Cursor	Use this to select the color (any of 63 colors) of the cursor by turning the adjustment dial. When the adjustment dial is pressed, the cursor color is returned to the initial value.
F5 switch Exit	Use this to return to the regular screen. (Refer to section 3.4.6.1.)
OVERLAY switch	When this is held down, the display is returned to the regular screen. (Refer to section 3.4.6.1.)

3.4.7 AUDIO mode

3.4.7.1 Audio level meter screen

<< Functions >>

- Audio levels displayed for 16 channels
- Selection of headphone output channels and volume control
- The audio mode functions only when SDI signals are input.

<< Screen >>

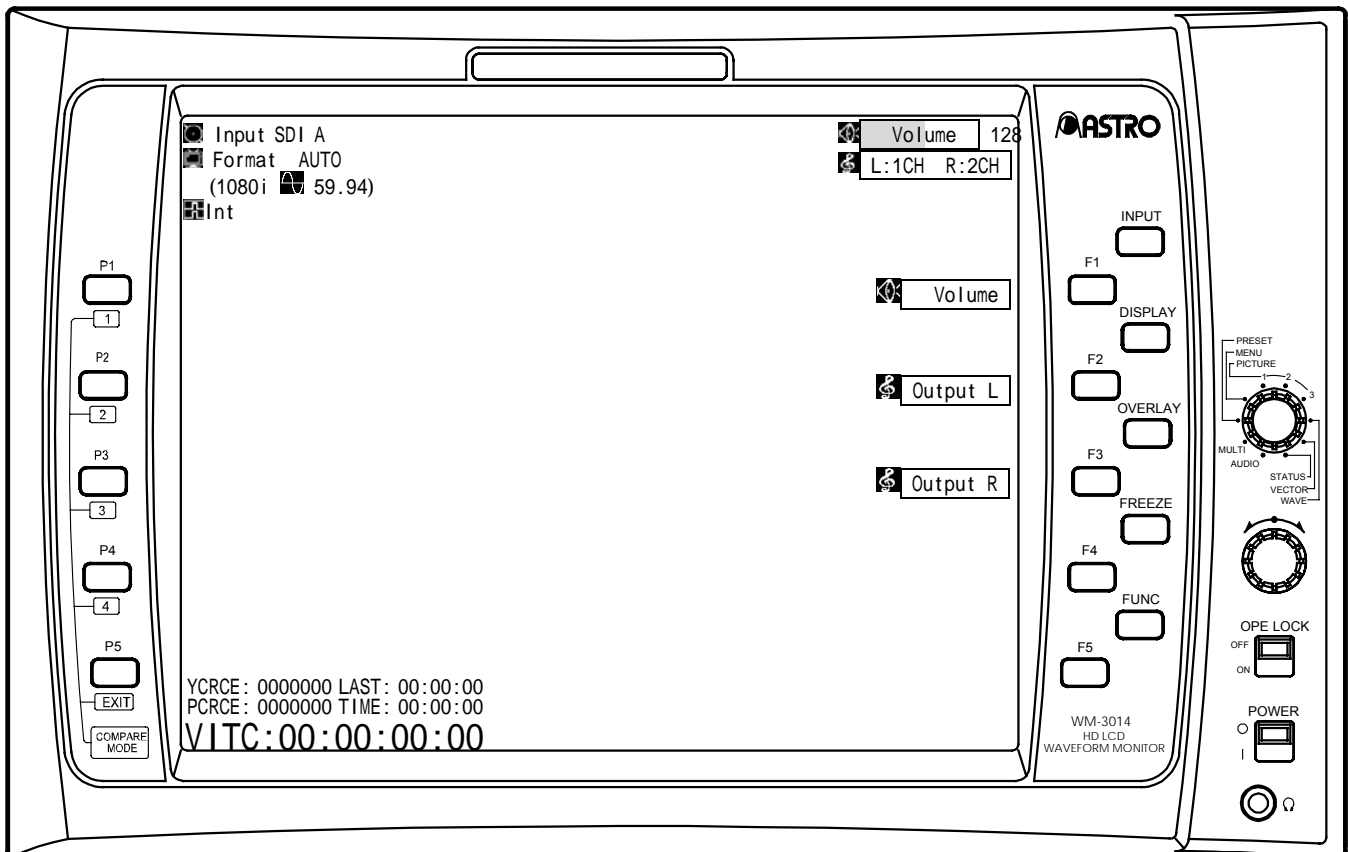

[Description of operations]

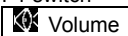
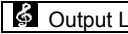
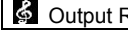
Switch	Description of function
FUNC switch	Use this to select the audio vector screen. (Refer to section 3.4.8.2.)
F1 switch  Volume	Use this to adjust the volume level by turning the adjustment dial. Variable range: 0 to 255 When the adjustment dial is pressed, the volume level is returned to the initial value.
F2 switch  Output L	Press the F2 switch, and turn the adjustment dial to set the headphone output left channel. When the adjustment dial is pressed, the output channel is returned to the initial value.
F3 switch  Output R	Press the F3 switch, and turn the adjustment dial to set the headphone output right channel. When the adjustment dial is pressed, the output channel is returned to the initial value.
F4 switch	No function.
F5 switch	No function.

- * Since the audio level meter perform pixel-skipping sampling, slight errors may occur in the values displayed for the high-frequency range.
- * The level meter may be disturbed for a moment when external sync signals are selected.

3.4.7.2 Audio vector screen

<< Functions >>

- Left/right vector display selected for headphone output
- Selection of headphone output channels and volume control
- Gain setting ($\times 1$, $\times 2$, $\times 4$, $\times 8$ or $\times 16$)

<< Screen >>

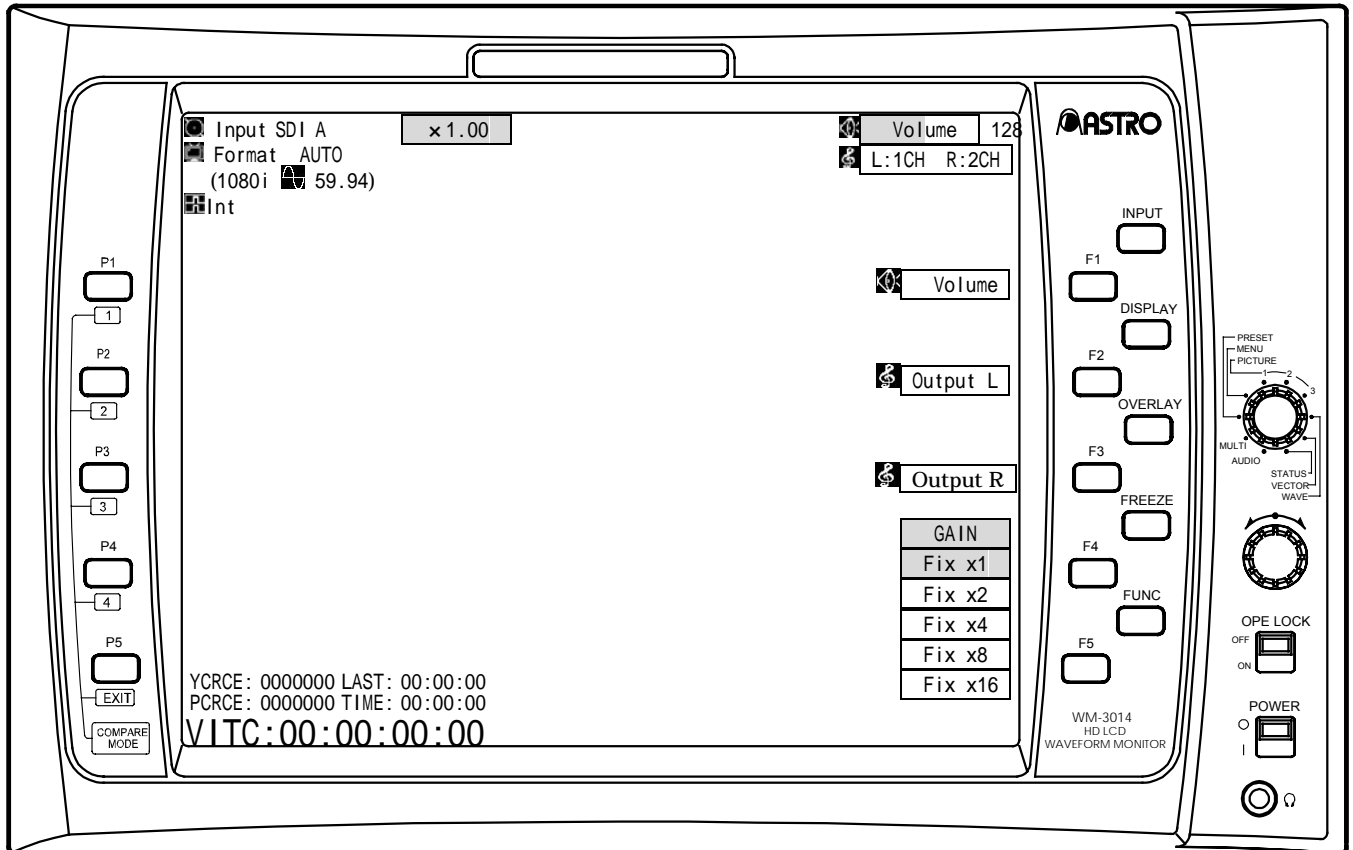

[Description of operations]

Switch	Description of function
FUNC switch	Use this to select the audio level meter screen. (Refer to section 3.4.8.1.)
F1 switch Volume	Use this to adjust the volume level by turning the adjustment dial. Variable range: 0 to 255 When the adjustment dial is pressed, the volume level is returned to the initial value.
F2 switch Output L	Press the F2 switch, and turn the adjustment dial to set the headphone output left channel. When the adjustment dial is pressed, the output channel is returned to the initial value.
F3 switch Output R	Press the F3 switch, and turn the adjustment dial to set the headphone output right channel. When the adjustment dial is pressed, the output channel is returned to the initial value.
F4 switch GAIN Fix $\times 1$ / GAIN Fix $\times 2$ / GAIN Fix $\times 4$ / GAIN Fix $\times 8$ / GAIN Fix $\times 16$	Use this to change the magnification rate of the audio vector waveforms. Each time the F4 switch is pressed, the rate changes in the sequence of $\times 1$, $\times 2$... $\times 16$.
F5 switch	No function.

3.4.7.3 Color setting screen

<< Functions >>



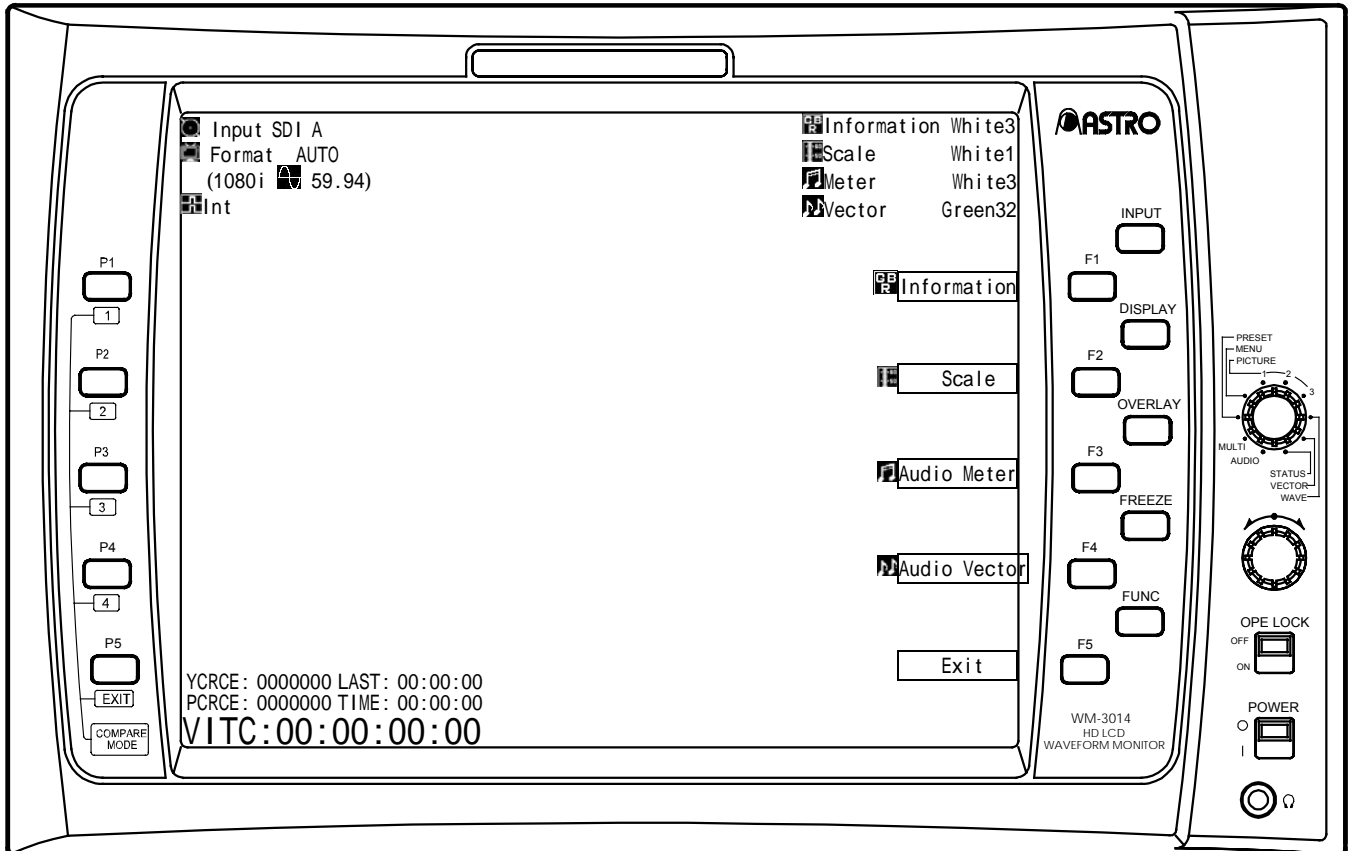

When the OVERLAY switch is held down in the AUDIO mode, the following settings can be performed on this screen.

- Character color
- Scale color
- Audio level meter color
- Audio vector waveform color

<< Screen >>



[Description of operations]

Switch	Description of function
FUNC switch	Use this to return to the previous screen.
F1 switch  Information	Use this to select the color (any of 63 colors) of the characters by turning the adjustment dial. When the adjustment dial is pressed, the character color is returned to the initial value.
F2 switch  Scale	Use this to select the color (any of 63 colors) of the scale by turning the adjustment dial. When the adjustment dial is pressed, the scale color is returned to the initial value.
F3 switch  Audio Meter	Use this to select the color (any of 63 colors) of the audio level meter by turning the adjustment dial. When the adjustment dial is pressed, the audio level meter color is returned to the initial value.
F4 switch  Audio Vector	Use this to select the color (any of 128 colors) of the audio vector by turning the adjustment dial. When the adjustment dial is pressed, the audio vector color is returned to the initial value.
F5 switch  Exit	Use this to return to the previous screen.
OVERLAY switch	When this is held down, the display is returned to the previous screen.

3.4.8 Multi mode

In the multi mode, the DISPLAY, OVERLAY and F1 to F5 switches do not work when the multi mode 1 screen is selected; when the multi mode 2 screen is selected, only the OVERLAY switch does not work.

* When composite signals are input, the data after the signals have been converted into component signals is displayed.

3.4.8.1 Multi mode 1 screen

<< Functions >>

The input images, waveforms (Y only), vectorscope and audio level meter are displayed at the same time. All values set in the PICTURE1 or PICTURE2 mode are valid.

Note: The H Delay, V Delay and MAG values set in the PICTURE3 mode are always set to OFF in all modes except in the PICTURE3 mode. The settings supported in all other modes are indicated below.

[Items common to the WAVEFORM and VECTOR modes]

Setting item	What happens on multi mode 1 screen
Scale color	As set
Cursor	Not displayed
Line select	Invalid

[WAVEFORM mode]

Setting item	What happens on multi mode 1 screen
Parade display / overlay display	Invalid
Y/G ON or OFF	Displayed at all times.
Pb (Cb) / B ON or OFF	Not displayed at any time.
Pr (Cr) / R ON or OFF	Not displayed at any time.
SWEEP	Fixed at 1H
GAIN	Fixed at initial value
MAG	Fixed at initial value
Vertical (gain) scroll	Fixed at initial value
Horizontal scroll	Fixed at initial value
Waveform YPbPr/GBR	Fixed at YPbPr
V Anc (Wave) ON or OFF	As set
H Blank ON or OFF	As set
Scale %/V	As set
Filter	As set
Waveform color, brightness	As set

[VECTOR mode]

Setting item	What happens on multi mode 1 screen
GAIN	As set
V Anc (Vect) ON or OFF	As set
Filter	As set
Vector color	As set

For details on the audio level meter in the multi mode, refer to "4.7 Concerning the audio level meter."

[Description of operations]

Switch	Description of function
FUNC switch	Use this to display the multi mode 2 screen. (Refer to section 3.2.5.2.)
F1 switch	No function.
F2 switch	No function.
F3 switch	No function.
F4 switch	No function.
F5 switch	No function.

3.4.8.2 Multi mode 2 screen

<< Functions >>

The input images and waveforms can be displayed simultaneously.
The following settings can be performed on this screen.

Setting item	What happens on multi mode 2 screen
Scale color	As set
Cursor	Not displayed
Line select	Invalid

[WAVEFORM mode]

Setting item	What happens on multi mode 2 screen
Parade display/overlay display	Value selected by switch
Y/G ON or OFF	As set
Pb (Cb) / B ON or OFF	As set
Pr (Cr) / R ON or OFF	As set
SWEEP	Fixed at 1H
GAIN	Fixed at 50%
MAG	Value selected by switch
Vertical (gain) scroll	Fixed at initial value
Horizontal scroll	Fixed at initial value
Waveform YPbPr/GBR/RGB	Value selected by switch
V Anc (Wave) ON or OFF	As set
H Blank ON or OFF	As set
Scale %/V	As set
Filter	As set
Waveform color, brightness	As set
MONO	Value selected by switch
MARKER	Value selected by switch

[Description of operations]

Switch	Description of function
FUNC switch	Use this to display the multi mode 1 screen. (Refer to section 3.4.5.1.)
F1 switch MAG	Use this to switch the magnification ratio of MAG between $\times 1 / 4:3 / \times 2 / \times 4$ (for HD) and $\times 1 / 4:3 / 16:9 / \times 4$ (for SD). When MAG is selected, only the images are displayed, and no waveforms are displayed.
F2 switch MONO	Use this to switch monochrome between ON and OFF.
F3 switch MARKER	Use this to switch the marker between ON and OFF.
F4 switch Waveform YPbPr / Waveform GBR / Waveform RGB	Use this to switch the waveform display between YPbPr, GBR and RGB.
F5 switch Parade / Overlay	Use this to switch between parade display (side-by-side display) and overlay display (superimposed display).

* In multi mode 2, the waveform is displayed using a scale of 10% increments. Waveforms can be displayed up to 110% on the full scale.

3.4.9 PRESET mode

<< Functions >>

By pressing (that is, not holding down) the P1 to P5 switches, the data stored in those switches can be called. There are no setting items, and the switches operate in the way they are designed to operate in the readout mode. It is only in the PRESET mode that the P1 to P5 switches can be pressed (that is, not held down). If no statuses are stored in the memory space, the picture-only display will appear when the data is called by the preset switch. The current statuses are stored in the memory space corresponding to the P1 to P5 switches by holding them down. The data stored in the memory space consists of modes, setting items common to the modes, and setting items which differ for each channel.

Holding down the P1 to P5 switches does not work in the MENU mode or PRESET mode.

<< Screen >>

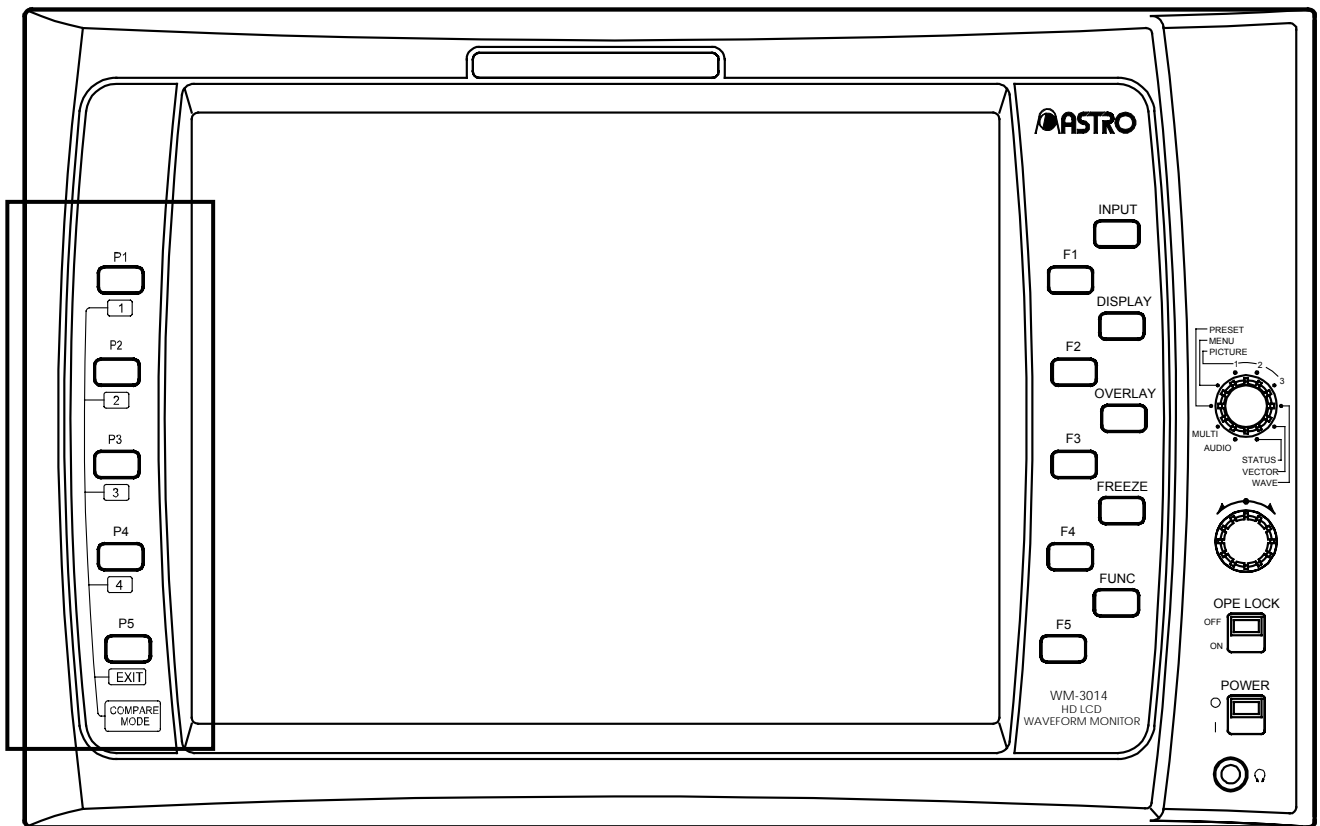

[Description of operations]

Description of function	
P1 switch	Use this to call the data stored in the P1 switch.
	If no data has been stored, the picture-only screen appears.
P2 switch	Use this to call the data stored in the P2 switch.
	If no data has been stored, the picture-only screen appears.
P3 switch	Use this to call the data stored in the P3 switch.
	If no data has been stored, the picture-only screen appears.
P4 switch	Use this to call the data stored in the P4 switch.
	If no data has been stored, the picture-only screen appears.
P5 switch	Use this to call the data stored in the P5 switch.
	If no data has been stored, the picture-only screen appears.

3.4.10 MENU mode

3.4.10.1 Regular screen

<< Functions >>

The signals on the menu can be displayed, and the following settings can be performed on the screen.



- Format selection
- Reference signal setting (*)
- Input signal color space setting
- User data calling and storing
- Power save mode setting
- Error count resetting
- Initializing
- NTSC setup selection

* When analog signals are input, the monitor will not operate properly unless the formats of the image signals and reference signals match.

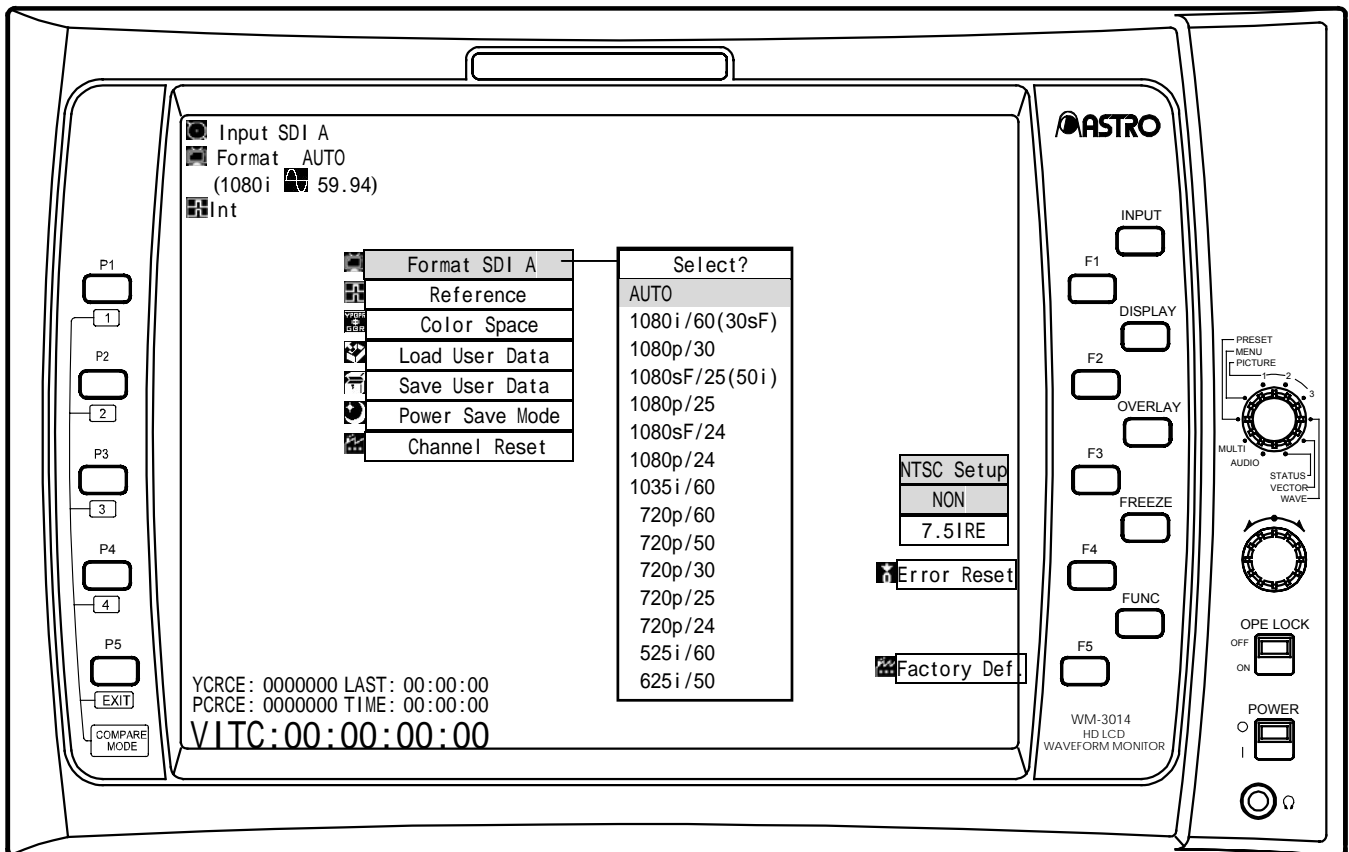







<< Screen >>



[Description of operations]

Switch	Description of function
FUNC switch	No function.
Turning the adjustment dial	Turn the dial to select the item to be set.
Pressing the adjustment dial	Press the dial to select the format, set the reference signal or initialize the setting of the currently selected channel (CRC error count reset). If the freeze status is established when the format is selected, the status is released.
F1 switch	No function.
F2 switch	No function.
F3 switch NTSC Setup <input type="checkbox"/> NON / NTSC Setup <input type="checkbox"/> 7.5IRE	Use this to set the setup of the NTSC composite signals to ON or OFF. Each time the F3 switch is pressed, NON is switched to 7.5IRE or vice versa.
F4 switch  ErrorReset	Use this to reset the CRC error count and elapsed time.
F5 switch  Factory Def.	When this is held down, the settings of all the channels are initialized, and the CRC error count is reset. (Refer to section 4.1.)

[Description of function]

Display	Description of function
 Format ****	Select the format of the currently selected channel here. If AUTO is selected, the input signals are automatically identified and their format is tracked. When analog component signals have been selected as the input signals, the 525i/60 or 625i/50 format cannot be selected (they are not displayed). When composite signals have been selected as the input signals, only the AUTO, 525i/59 or 625i/50 format can be selected. In regard to the PAL signals, the actual waveforms of the 3 lines each at the start and end of the video signals will be more disturbed than in actuality.
 Reference	Select the sync signals here. To perform operations using the internal sync signals, select <input type="checkbox"/> Int, to input HD tri-level sync signals, select <input type="checkbox"/> Ref HD, to input NTSC black burst signals, select <input type="checkbox"/> Ref BB (525), and to input PAL black burst signals, select <input type="checkbox"/> Ref BB (625). Bear in mind that black burst synchronization cannot be supported when the input channels contain analog signals.
 Color Space	Select either YPbPr signals or GBR signals for the input video signals here.
 Load User Data	Load the data which has been stored in User1 to User7.
 Save User Data	Save 7 sets of current settings in User1 to User7. While data is being saved,  is displayed. Do not turn off the power while data is being saved. Otherwise, the initial values may be saved, instead of the values to be saved, for all the data which can be saved by the users.
 Power Save Mode	The low power consumption function which involves turning off the backlight of the liquid crystal display can be selected here. When the prescribed period elapses without performing any WM-3014 operations, the backlight of the liquid crystal display is turned off, and the low power consumption mode is established. When any switch is pressed in this status, the backlight of the liquid crystal display is turned back on, and the monitor is returned to its normal status.
 Channel Reset	Use this to return the setting items of the currently selected channel to the initial statuses. (Refer to section 4.1.)

CAUTION

Bear in mind that malfunctioning will occur if the reference signal is a signal which is not supported by the monitor. Even if the reference signal is normal, the display screen may move to the left or right by one pixel before and after.

3.4.10.2 Color setting screen

<< Functions >>



When the OVERLAY switch is held down in the MENU mode, the following settings can be performed on this screen.

- Character color

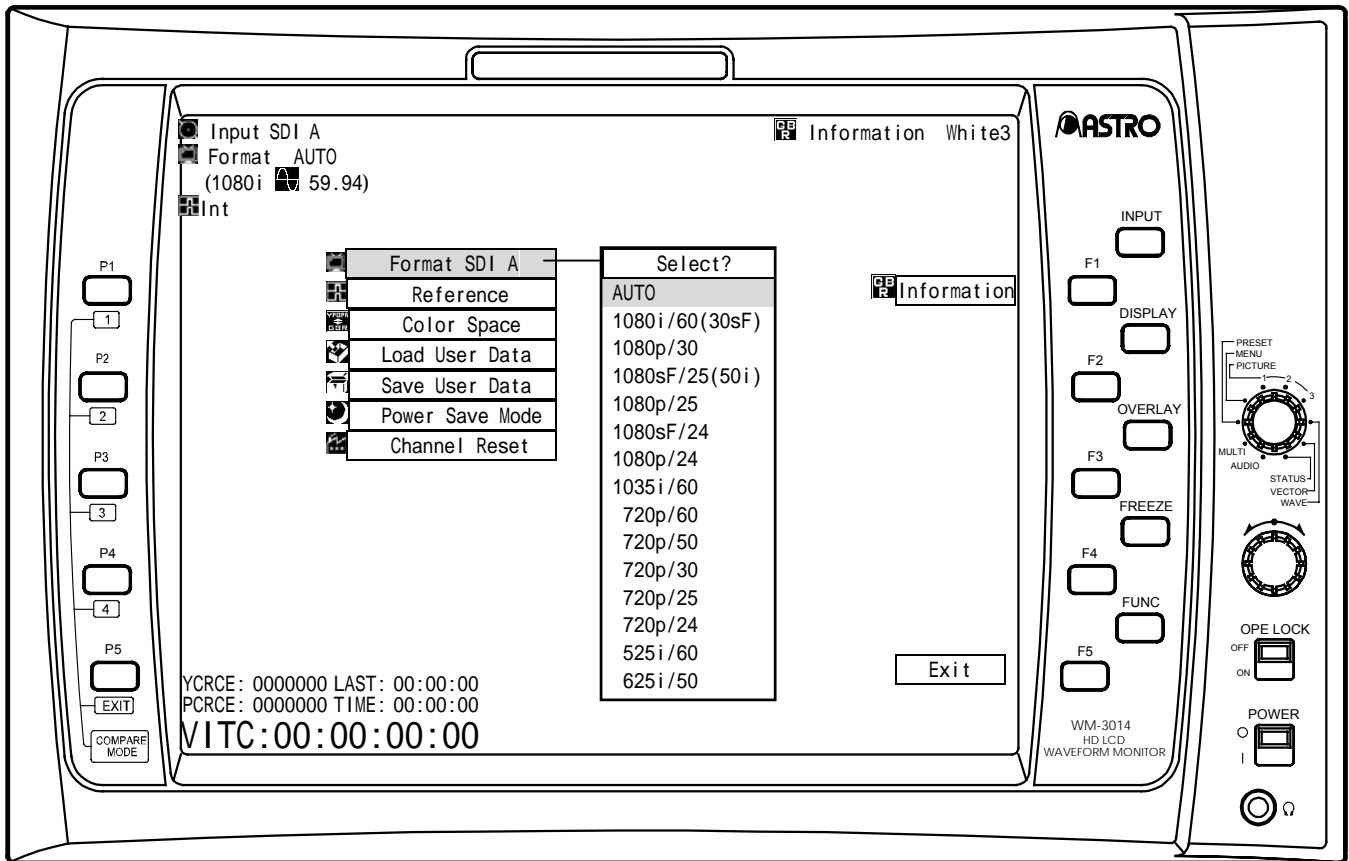
<< Screen >>

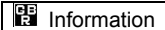

[Description of operations]

Switch	Description of function
FUNC switch	Use this to return to the regular screen. (Refer to section 3.4.10.1.)
F1 switch 	Use this to select the color (any of 63 colors) of the characters by turning the adjustment dial. When the adjustment dial is pressed, the character color is returned to the initial value.
F2 switch	No function.
F3 switch	No function.
F4 switch	No function.
F5 switch 	Use this to return to the regular screen. (Refer to section 3.4.10.1.)
OVERLAY switch	When this is held down, the display is returned to the regular screen. (Refer to section 3.4.10.1.)

3.4.11 Compare mode

3.4.11.1 Outline

<< Outline >>

The compare mode is established by pressing P1, P2, P3 or P4 in the freeze status. This mode is useful for comparing the current data against the freeze data in different ways.

<< Operation method >>

In the freeze mode, the F1 to F5 functions change as shown below.

- P1: Establishes the compare mode 1.
- P2: Establishes the compare mode 2.
- P3: Establishes the compare mode 3.
- P4: Establishes the compare mode 4.
- P5: Returns to the normal mode.

3.4.11.2 Compare mode 1

<< Outline >>

In this mode, the picture screens of the freeze data and current data are superimposed onto each other, and displayed.

<< Functions >>

- H Delay
- V Delay
- MAG

<< Screen >>

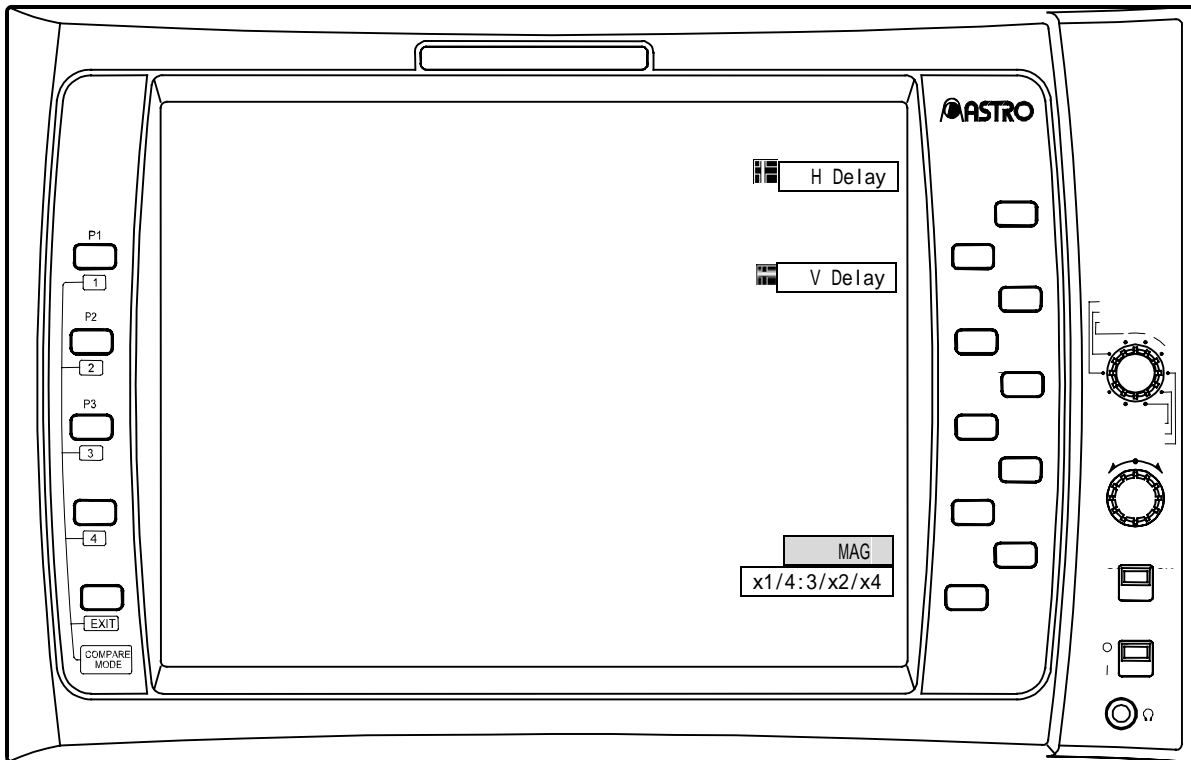

[Description of operations]

Switch	Description of function
FUNC switch	No function.
F1 switch H Delay	Use this to set H Delay to ON or OFF.
F2 switch V Delay	Use this to set V Delay to ON or OFF.
F3 switch	No function.
F4 switch	No function.
F5 switch MAG x1 / 4:3 / x2 / x4	Use this to switch the magnification ratio of MAG between x1 / 4:3 / x2 / x4 (for HD) and x1 / 4:3 / 16:9 / x4 (for SD).
Turning the adjustment dial	Turn the dial to change the ratio at which the freeze data and current data are superimposed onto each other.
Pressing the adjustment dial	No function.

3.4.11.3 Compare mode 2

<< Outline >>

In this mode, the vectorscopes of the freeze data and current data are superimposed onto each other, and displayed.

<< Functions >>

- Vectorscope expansion
- Line select function
- Freeze data ON/OFF
- Live Data ON/OFF
- V Ancillary (Vect) switching
- Scale switching
- LPF (Vect) switching

* When composite signals are input, the data after the signals have been converted into component signals is displayed.

<< Screen >>

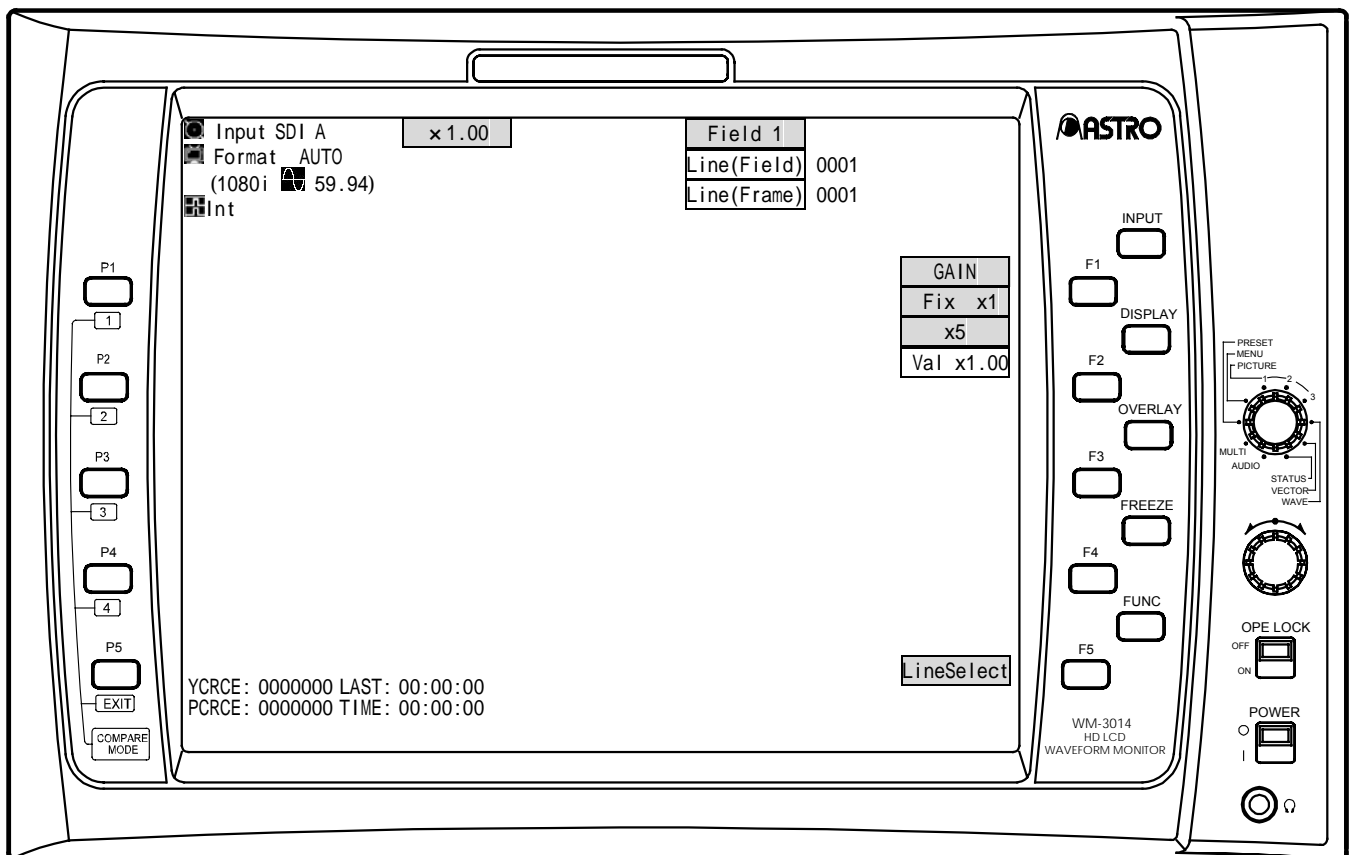

[Description of operations] (Regular screen)

Switch	Description of function	
FUNC switch	Use this to set the display to the VECTOR mode setting screen.	
Turning the adjustment dial	When the gain setting is fixed Fix $\times 1 / \times 5$	No function.
	When the gain setting is variable Val $\times^{*} .^{**}$	Turn the dial to set the magnification rate of the gain. (Variable range: 0.03 to 7.97)
	When line select is ON	Turn the dial to increment or decrement the lines. The line select ON/OFF and the lines are coupled in the WAVEFORM mode, VECTOR mode and STATUS mode.
Pressing the adjustment dial	When the gain setting is fixed Fix $\times 1 / \times 5$	No function.
	When the gain setting is variable Val $\times^{*} .^{**}$	The gain is an integral value after the decimal places have been rounded down (with a figure of 4 or below) or rounded up (with a figure of 5 or above). (All values below 0.49 are set to 0.03; similarly, all values above 7.00 are set to 7.00.) If the gain magnification rate is an integer, it is increased in 1.00 increments, and when 7.00 is reached, it is returned to 1.00.
	When line select is ON	Use the dial to select the field. (Field switching is enabled only with the interlacing or segmented frame format.)
F1 switch GAIN Fix $\times 1$ / GAIN $\times 5$ / GAIN Val $\times^{*} .^{**}$	Use this switch to set line select to OFF and to switch between the fixed (Fix $\times 1 / \times 5$) and variable ($\times^{*} .^{**}$) gain setting. In the Fix $\times 1$ status, the loci between the pixels are interpolated for the display; in other statuses, only the points are displayed.	
F2 switch LineSelect	Use this to set line select to ON or OFF. When line select is ON, the gain setting display is fixed (Fix $\times 1$).	
F3 switch Freezed Data	Use this to set the Freeze Data to ON or OFF. (This data cannot be set to OFF if Live Data is set to OFF.)	
F4 switch Live Data	Use this to set the Live Data to ON or OFF. (This data cannot be set to OFF if Freeze Data is set to OFF.)	
F5 switch	No function.	

[Description of operations] VECTOR mode setting screen

Switch	Description of function
FUNC switch	Use this to set the display to the regular screen.
Adjustment dial	No function.
F1 switch	No function.
F2 switch V Anc (Vect) ON / V Anc (Vect) OFF	Use this to set V ancillary to ON or OFF. This takes effect only when the VECTOR mode is established.
F3 switch	No function.
F4 switch Scale 100% / Scale 75%	Use this to switch the scale between 100% and 75%.
F5 switch Filter (Vect) NON / Filter (Vect) LPF / Filter (Vect) Average	Use this to set to filter (Wave) or no filter and set the type of filter. This takes effect only when the VECTOR mode is established. LPF frequency characteristics Y: 6 MHz (-3 dB), PbPr: 3 MHz (-3 dB) "Average" is the average of the data of the 8 pixels immediately before and after.

3.4.11.4 Compare mode 3

<< Functions >>

In this mode, the waveforms of the images for the freeze data and current input data are displayed simultaneously side by side at the left and right. The settings are as shown below.

Setting item	What happens on multi mode 2 screen
Scale color	As set
Cursor	As set
Line select	Invalid

[WAVEFORM mode]

Setting item	What happens on multi mode 2 screen
Parade display/overlay display	Value selected by switch
Y/G ON or OFF	Value selected by switch
Pb (Cb) / B ON or OFF	Value selected by switch
Pr (Cr) / R ON or OFF	Value selected by switch
SWEEP	Fixed at 1H
GAIN	Fixed at 100%
MAG	×1
Vertical (gain) scroll	Fixed at initial value
Horizontal scroll	Fixed at initial value
Waveform YPbPr/GBR/RGB	Value selected by switch
V Anc (Wave) ON or OFF	As set
H Blank ON or OFF	As set
Scale %/V	As set
Filter	As set
Waveform color, brightness	As set
MONO	As set
MARKER	As set

[Description of operations]

Switch	Description of function
FUNC switch	No function.
F1 switch Parade / Overlay	Use this to switch between parade display (side-by-side display) and overlay display (superimposed display).
F2 switch Y	Use this to set Y/G to ON or OFF.
F3 switch Pb (Cb)	Use this to set Pb/B to ON or OFF.
F4 switch Pr (Cr)	Use this to set Pr/R to ON or OFF.
F5 switch Waveform YPbPr / Waveform GBR / Waveform RGB	Use this to switch the waveform display between YPbPr, GBR and RGB.

3.4.11.5 Compare mode 4

<< Functions >>

In this mode, the freeze data and current input data are displayed simultaneously. The images are displayed simultaneously side by side at the left and right.

One of the Y/Pb/Pr (or G/B/R) waveforms is selected, superimposed and displayed. The settings are as shown below.

Setting item	What happens on multi mode 2 screen
Scale color	As set
Cursor	Not displayed
Line select	Invalid

[WAVEFORM mode]

Setting item	What happens on multi mode 2 screen
SWEEP	Fixed at 1H
GAIN	Fixed at 100%
MAG	Fixed at initial value
Vertical (gain) scroll	Fixed at initial value
Horizontal scroll	Fixed at initial value
Waveform YPbPr/GBR/RGB	Value selected by switch
V Anc (Wave) ON or OFF	As set
H Blank ON or OFF	As set
Scale %/V	As set
Filter	As set
Waveform color, brightness	As set
MONO	As set
MARKER	As set

[Description of operations]

Switch	Description of function
FUNC switch	Use this to set the display to the multi mode 1 screen. (Refer to section 3.4.5.1.)
F1 switch Color CH	Use this to select one of the Y/Pb/Pr (or G/B/R) waveforms to be superimposed and displayed.
F2 switch LineSelect	Use this to set line select to ON or OFF. When line select is ON, the gain setting display is fixed (Fix ×1).
F3 switch Freezed Data	Use this to set the Freeze Data to ON or OFF. (This data cannot be set to OFF if Live Data is set to OFF.)
F4 switch Live Data	Use this to set the Live Data to ON or OFF. (This data cannot be set to OFF if Freeze Data is set to OFF.)
F5 switch Waveform YPbPr / Waveform GBR / Waveform RGB	Use this to switch the waveform display between YPbPr, GBR and RGB.

4

MAIN SPECIFICATIONS

4.1 Input formats

Format		Frame Rate (Hz)	Active Line per Frame	Total Line Per Frame	Line Frequency (kHz)	Samples per Active Line	Samples per Total Line	Scanning *1	*2
1035i/60	1035i/59.94	30/1.001	1035	1125	33.72	1920	2200	i	(1)
	1035i/60	30	1035	1125	33.75	1920	2200	i	
1080i/60	1080i/59.94	30/1.001	1080	1125	33.72	1920	2200	i	(1)
	1080sF/29.97							sF	(2)
1080i/60	1080i/60	30	1080	1125	33.75	1920	2200	i	(1)
	1080sF/30							sF	(2)
1080p/30	1080p/29.97	30/1.001	1080	1125	33.72	1920	2200	p	(2)
	1080p/30							p	
1080sF/25 (1080i/50)	1080sF/25	25	1080	1125	28.13	1920	2640	sF	(2)
	1080i/50							i	
1080p/25	1080p/25	25	1080	1125	28.13	1920	2640	p	(2)
1080sF/24	1080sF/23.98	24/1.001	1080	1125	26.97	1920	2750	sF	(2)
	1080sF/24							sF	
1080p/24	1080p/23.98	24/1.001	1080	1125	26.97	1920	2750	p	(2)
	1080p/24							p	
720p/60	720p/59.94	60/1.001	720	750	44.96	1280	1650	p	(3)
	720p/60							p	
720p/50	720p/50	50	720	750	36.00	1280	1980	p	(3)
720p/30	720p/29.97	30/1.001	720	750	22.48	1280	3300	p	(3)
	720p/30							p	
720p/25	720p/25	25	720	750	18.75	1280	3960	p	(3)
720p/24	720p/23.98	24/1.001	720	750	17.98	1280	4125	p	(3)
	720p/24							p	
525i/60	525i/59.94	60/1.001	487	525	15.73	720	858	i	(4)
625i/50	625i/50	50	576	625	15.63	720	864	i	(4)

*1: Scanning abbreviations
 i = Interlace
 sF = Segmented Frame
 p = Progressive

*2: Standards
 (1) BTA S-001B, S-002B, S-004B complied with (2) SMPTE 274M complied with
 (3) SMPTE 296M complied with (4) SMPTE 259M complied with, ITU-R . BT656

4.2 Input signal systems

SDI input specification	Specification	
SDI input	HDTV	BTA S-004B complied with, SMPTE 292M complied with, NRZI SDI signal
	SDTV	SMPTE 259M complied with, NRZI SDI signal
	Field (frame) frequency, 60.00/59.94 [Hz], etc. automatically tracked Automatic tracking of input format enabled	

Analog input specification	Specification	
HDTV YPbPr input	BTA S-001B complied with, SMPTE 274M complied with, SMPTE 296M complied with,	
	Field frequency, 60.00/59.94 [Hz], etc. automatically tracked Automatic scanning of input format enabled	
	Y on Sync or reference signal selected for synchronization Video signals: 75Ω ±5% termination Reference signal: 75Ω ±5% termination (Signal measurement accuracy: Within ±5%, horizontal jitter: less than 10ns)	

Composite input specification	Specification	
COMPOSITE input	NTSC	SMPTE170M complied with
	PAL	ITU.R BT624-4 complied with in part * PAL-M and PAL-N are not supported.
	Automatic scanning of input format enabled (Signal measurement accuracy: Within ±5%)	



When composite signals are input, the 3 lines each at the start and end of the video signals will appear to be disturbed compared with the actual waveforms, and displayed.

4.3 Display system

Display system	Specification	
Liquid crystal	a-Si TFT LCD	
Colors displayed	16,194,277 colors	
Contrast ratio	300:1 (Max)	
Angle of view	105 degrees vertically, 120 degrees horizontally	
Brightness	250 cd/m ² (max)	
Screen size	6.3 inch	
Resolution	1024 (H) × 768 (V) Pixels	
Image area	HDTV	960 (H) × 540 (V) Pixels
Pixel pitch	0.126 (W) × 0.126 (H) mm	

4.4 Headphones output format

Maximum output	50mW \pm 5% (32 Ω /1kHz)
Frequency response	100Hz to 20kHz (0dB to -3dB)

4.5 Concerning the adjustment values

■ Brightness

The offset level of the luminance signal can be varied in the range of -50.00 to +50.00%. This applies to the G brightness, B brightness and R brightness as well.

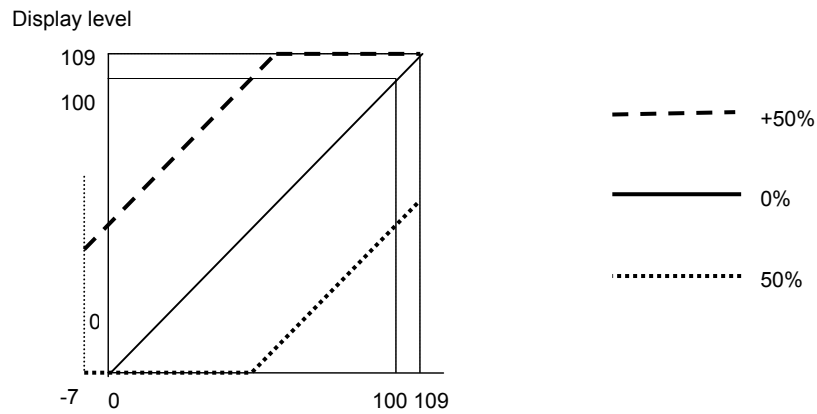

■ Contrast

The level of the luminance signal can be varied in the range of 0.0 to 200.0%. This applies to the G contrast, B contrast and R contrast as well.

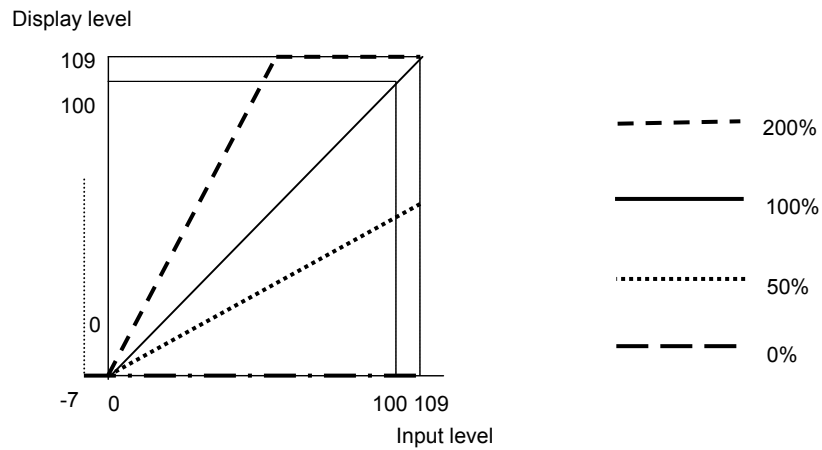

■ Chroma, Pb (Cb), Pr (Cr)

The level of the chrominance signals can be varied in the range of 0.0 to 200.0%.

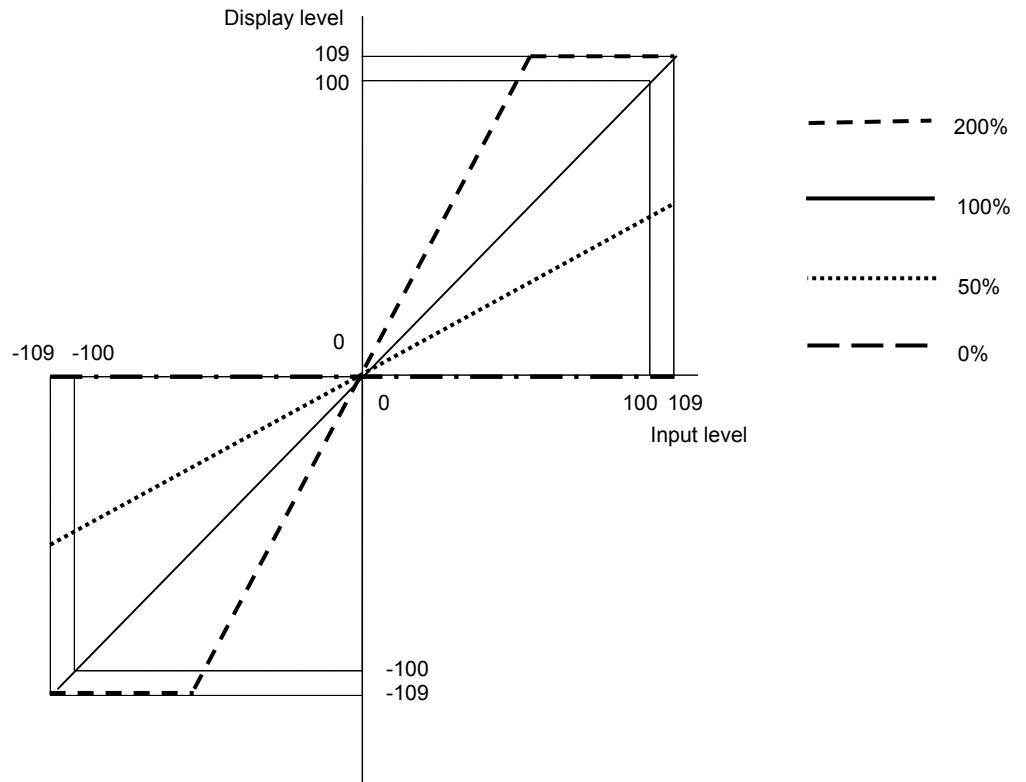

■ Precautions for chroma boost function

The figure below shows the relationship between the Pb and Pr input signals and the display level when the chroma boost function ($\times 3$) has been set to ON.

Bear in mind that if the result of multiplying the chroma signal value by 3 exceeds $\pm 109\%$, a limit will be imposed at $\pm 109\%$.

Example: A 30% signal will be expanded to 90%, but when a 100% signal is multiplied by 3, it will be increased to 109% only.

If Pb is a 30% signal and Pr a 100% signal, the result will be 90% for Pb and 109% for Pr, causing the color balance to be changed entirely.

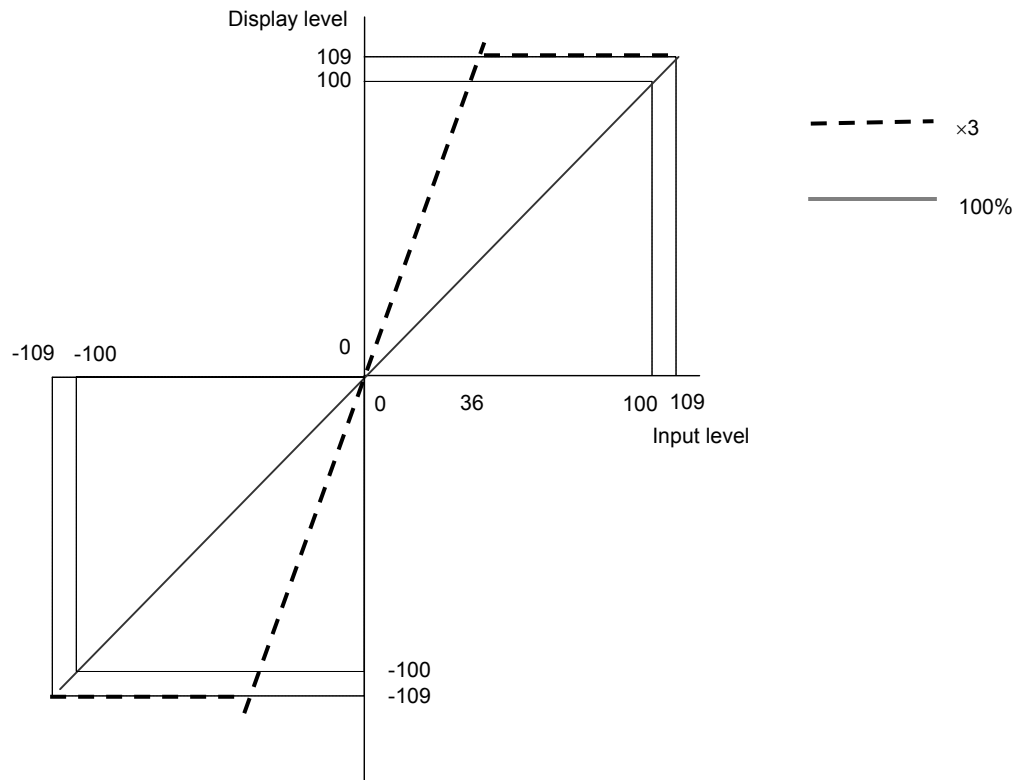

For GBR input signals, the chroma boost function works as a function for changing the B and R gain.

4.6 Concerning the 4:3 function

- **With a resolution of 1920 × 1080 pixels**

An image with an area of 1440 × 1080 pixels near the center is cut out from the image area and displayed with 1024 × 768 pixels.

The same processing as with 1920 × 1080 pixels is used with 1920 × 1035 pixels as well.

□

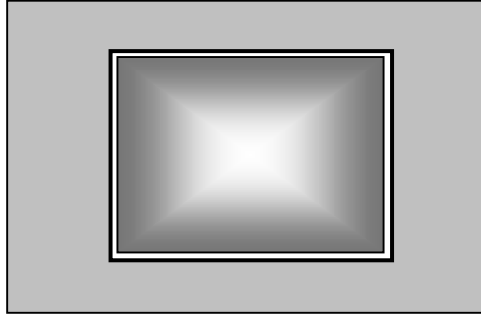

- **With a resolution of 1280 × 720 pixels**

An image with an area of 960 × 720 pixels near the center is cut out from the image area and displayed.

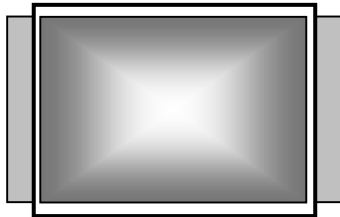

- **With a resolution of 720 × 487 and 720 × 576 pixels**

With the 625i/50 format, the image area is enlarged and displayed; with the 525i/60 format, an area of 720 × 480 pixels is enlarged to 1024 × 768 pixels and displayed.

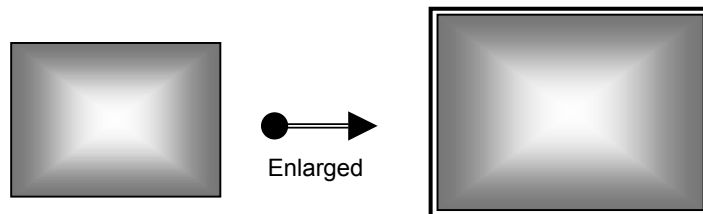



Explanation of displays



••• This indicates the image.



••• This indicates the liquid crystal screen.

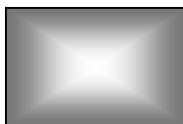

••• This indicates an image displayed in the 4:3 format.

4.7 Concerning the audio level meter

The audio level meter indicates the level as follows.
Audio standards: BTA S-006B and SMPTE 272M-A

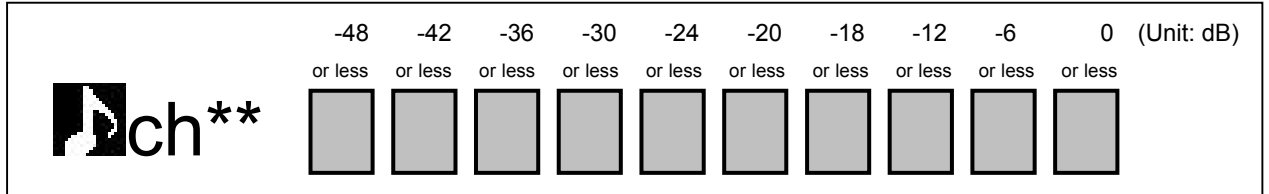

CAUTION

The audio level meter is displayed only when SDI signals are selected. When sync signals have been set as the external reference, the level meter may malfunction although this rarely happens.

In the following cases, the audio data cannot be sampled by this monitor.

With the HD format:

ADF for the audio auxiliary data fails to come immediately after the CRC data.

With the SD format:

ADF for the audio auxiliary data fails to come immediately after EAV.

NOTE

The level is displayed in the left-most cell when audio signals with a level of less than -48 dB are supplied. This makes it possible to visually identify whether sound is input.

4.8 Settings at initialization

The settings established when the WM-3014 was shipped from the factory and when they are initialized are listed below.

Common setting items

The settings for the following items are the same whether for SDI A, SDI B, Analog or VBS channels. These settings are factory default settings, and they are not initialized unless the settings of all the channels are initialized.

Setting item	Setting/adjustment range	Initial value
Input	SDI A, SDI B, Analog, VBS	SDI A
Display	ON/OFF	ON
Overlay	ON, OFF	OFF
Half Turn	ON, OFF	OFF
Freeze (*)	ON, OFF	OFF
Marker	ON/OFF (Types of markers: FRAME, CENTER, USER, 95%, 93%, 88%, 80%, 4:3, 13:9, 14:9, 2.35:1, 1.85:1, 1.66:1)	OFF (Types of markers: FRAME, CENTER)
NTSC Setup	NON, 7.5IRE	7.5IRE
User Marker H/V	0 to 99%	50%
Color temperature	D65, D93	D65
G-Bright	-50.0 to +50.0%	0.0%
B-Bright	-50.0 to +50.0%	0.0%
R-Bright	-50.0 to +50.0%	0.0%
G-Contrast	0.0 to 200.0%	100.0%
B-Contrast	0.0 to 200.0%	100.0%
R-Contrast	0.0 to 200.0%	100.0%
G-Gamma	1.100 to 4.400	2.200
B-Gamma	1.100 to 4.400	2.200
R-Gamma	1.100 to 4.400	2.200
H Delay (*)	ON, OFF	OFF
V Delay (*)	ON, OFF	OFF
MAG	×1, 4:3, ×2 (16:9), ×4	×1
Parade / Overlay	Parade, Overlay	Parade
Y	ON, OFF	ON
Pb (Cb)	ON, OFF	ON
Pr (Cr)	ON, OFF	ON
LineSelect	ON, OFF	OFF

Setting item	Setting/adjustment range	Initial value
SWEEP	1H, 2H, 1F, 2F	1H
GAIN (WAVEFORM mode)	×0.03 to ×7.97	×1
CTR Pos. C	Aligned, Center	Aligned
H cursor	ON, OFF	OFF
V cursor	ON, OFF	OFF
MOVE	BASE, OFFSET, TRACK	BASE
Waveform	YPbPr, GBR	YPbPr
V Anc (Wave)	ON, OFF	OFF
H Blank	ON, OFF	OFF
Scale (unit)	%, V, Non	%
Filter (Wave)	NON, LPF, Average	LPF
GAIN (VECTOR mode)	×0.03 to ×7.97	Fix ×1
V Anc (Vect)	ON, OFF	OFF
Scale (display)	100%, 75%	100%
Filter (Vect)	NON, LPF, Average	LPF
Cardinal numbers	HEX, DEC, OCT, BIN	HEX
GAIN (AUDIO mode)	Fix ×1, ×2, ×4, ×8, ×16	Fix ×1
Animation	ON, OFF	ON
Power Save Mode	1, 5, 10, 15, 30, 60, NON	NON

* These settings are not stored in the memory. They are always OFF when the power is turned on.

Setting items by channel

The following items are set separately for each SDI A, SDI B, analog channel and composite channel.

Setting item	Setting/adjustment range	Initial value
Bright	-50.0 to +50.0%	0.00%
Contrast	0.0 to 200.0%	100.0%
Pb (Cb)	0.0 to 200.0%	100.0%
Pr (Cr)	0.0 to 200.0%	100.0%
Chroma_UP	ON, OFF	OFF
Y Gamma	1.100 to 4.400	2.200
Peaking	OFF, 1 to 100	OFF
Filter	ON, OFF	ON
Mono	ON, OFF	OFF
Green	ON, OFF	ON

Setting item	Setting/adjustment range		Initial value
Blue	ON, OFF		ON
Red	ON, OFF		ON
Volume	0 to 255		128
Output	1CH to 16CH		L:1CH•R:2CH
Format	SDI	All 15 types	AUTO
	Analog	All 13 types	AUTO
	COMPOSITE	All 2 types	AUTO
Reference	SDI	Int, Ref HD, Ref BB (525), Ref BB (625)	Int
	Analog	Int, Ref HD	Int
	COMPOSITE	Int, Ref HD, Ref BB (525), Ref BB (625)	Int
Color Space	YPbPr, GBR		YPbPr
Information Color	G: 0 to 3 B: 0 to 3 R: All 63 colors (no black) from 0 to 3		White3 (G: 2, B: 2, R: 2)
Marker Color	G: 0 to 3 B: 0 to 3 R: All 64 colors from 0 to 3		White3 (G: 3, B: 3, R: 3)
Scale Color	G: 0 to 3 B: 0 to 3 R: All 63 colors (no black) from 0 to 3		White1 (G: 1, B: 1, R: 1)
Waveform Color	Color1 to 31 White: All 62 colors from 1 to 31		Color15
Cursor Color	G: 0 to 3 B: 0 to 3 R: All 63 colors (no black) from 0 to 3		Yellow2 (G: 2, B: 0, R: 2)
Vector Color	Blue: 1 to 32, Red: 1 to 32 Green: 1 to 32, White: 1 to 32 Color: All 160 colors from 1 to 32		Green16
Audio Meter	G: 0 to 3 B: 0 to 3 R: All 63 colors (no black) from 0 to 3		White3 (G: 2, B: 2, R: 2)
Audio Vector	Blue: 1 to 32 Red: 1 to 32 Green: 1 to 32 White: All 160 colors from 1 to 32		Green32

4.9 General specifications

Table 4.1 Operating environment and ratings for WM-3014 (main unit)

Operating temperature range	0 to 40 °C
Operating humidity range	30 to 80%RH (ambient temperature must be in the 0 to 40 °C range and no condensation must be allowed to form)
Rated voltage	DC10-18V
Power consumption	20W (typ)
Service life	35,000 hours (with LCD backlight brightness reduced to one-half)
Dimensions	210 (W) × 133 (H) × 83 (D) mm (excluding protrusions) 210 (W) × 133 (H) × 105 (D) mm (including protrusions)
Weight	Approx. 1.5 kg

Table 4.2 Operating environment and ratings for accessory AC/DC adapter

Rated output voltage	12V ± 5%	
Rated output current	5.0A	
Maximum output power	60W	
Input voltage	Rating: 100-240V (AC)	
Output plug polarities	Pin 1	GND
	Pin 2	NC
	Pin 3	NC
	Pin 4	POWER

4.10 Outline drawings

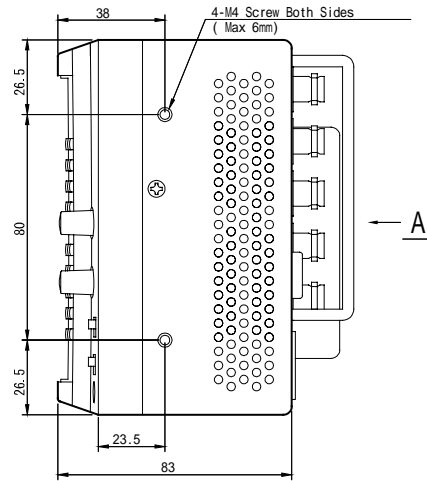
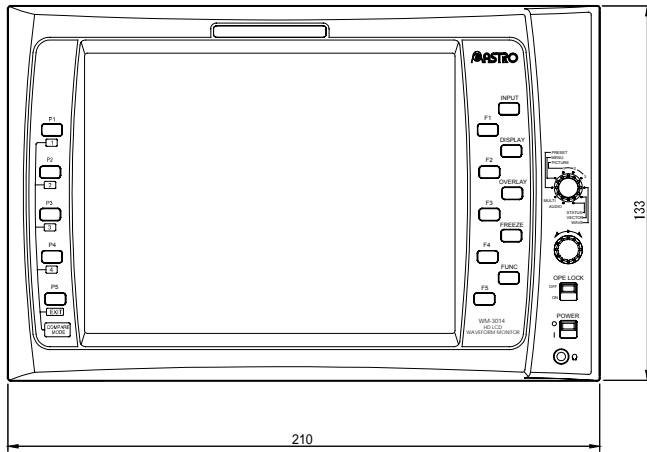
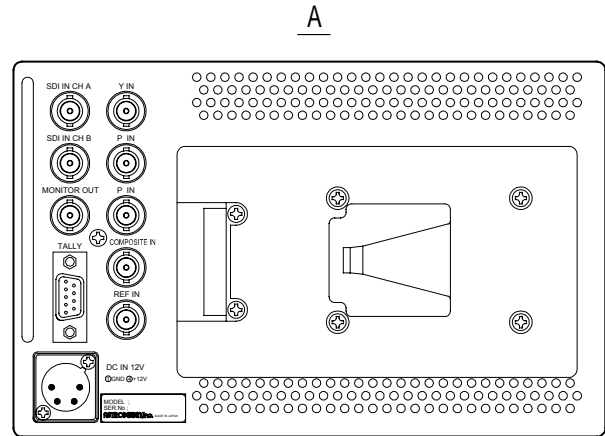
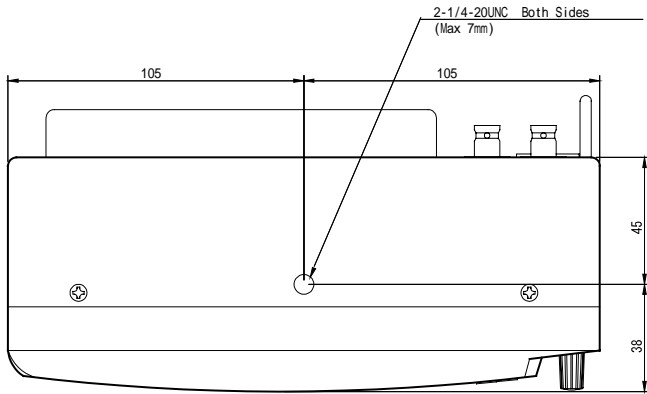

5

STANDARD AND OPTIONAL ACCESSORIES

5.1 Standard accessories

WM-3014 instruction manual	1 copy
AC/DC adapter	1 pc
M4 screws (for attaching rack-mounting fixtures)	4 pcs
Clear bumpons	4 pcs

6

MAINTENANCE AND OTHER PROCEDURES

When the monitor does not operate properly

Symptom	What is to be checked
The image is not displayed properly.	<ul style="list-style-type: none"> ● Has the correct format been set? ● Has  Color Space (YPbPr/GBR) been set correctly? ● Has the input channel been set correctly?
The front panel switches fail to operate.	<ul style="list-style-type: none"> ● Is the LOCK switch at the ON position?
The remote controller fails to operate.	Check the method used to operate the remote controller. Have the correct level, edge, etc. been selected?
When the LOCK switch is set to ON, the markers and other settings change.	<ul style="list-style-type: none"> ● Check the method used to operate the remote controller. ● Check the settings 1 to 6 on the remote controllers. (Refer to section 4.7.) If the remote connector is unconnected, the monitor will judge it to be open (remote switch at OFF).
When composite signals are input, the waveforms and vectorscope waveforms are disturbed.	<ul style="list-style-type: none"> ● Check the input signals. Due to restrictions imposed by the internal circuitry, the 3 lines each at the start and end of the video signals will appear to be more disturbed than the actual waveforms when composite signals are input.
Something is wrong with the image quality.	<ul style="list-style-type: none"> ● Hold down the MONO switch to set to the LCD screen adjustment status, and check whether something is wrong with the settings.

When trouble or malfunctioning occurs

- In the unlikely event that trouble or malfunctioning should occur, contact your dealer or an Astrodesign sales representative.
- If trouble should occur in the LCD panel, the user will be charged for repairs and parts replaced even within the warranty period.

NOTICE

An incorrectly collated manual or a manual with missing pages will be replaced.

All copyrights pertaining to this manual are the property of Astrodesign.

This manual may not be used or copied in whole or in part without permission.

The contents of this manual are subject to change without prior notice due to improvements.

The manufacturer will not be liable for any outcome which results from the incorrect operation of the product.

All inquiries concerning this product should be addressed to your dealer or to the manufacturer at the contact numbers given below.

The products and product names mentioned in this manual are the trademarks and registered trademarks of the companies concerned.

D0070

ASTRODESIGN, Inc.

URL <http://www.astrodesign.co.jp>

Sales and Marketing Division

TEL: +81 3-5720-5300 FAX: +81 3-5720-6353

2-6-17, Haramachi, Meguro-ku, Tokyo 152-0011 Japan